

LASER SENSOR LS-B200

Thank you for purchasing the TOPCON LS-B200. For the best performance of the instruments, please read these instructions carefully and keep them in a convenient location for future reference.

GENERAL HANDLING PRECAUTIONS

Before starting work or operation, be sure to check that the system is functioning properly.

- Remove the batteries from the instrument when you will not be using it for long period.
- Replace all 4 dry batteries with new ones at the same time. Do not mix used and new dry batteries, and do not mix different types of dry batteries together.
- Use alkaline dry batteries. Nickel hydrogen dry batteries and nickel cadmium dry batteries can be used too, but the operating time is different from the time of alkaline dry batteries.
- Do not submerge the instrument in water.
- This instrument is designed based on the International Standard IPX 6, but it is not protected from a high pressure water stream or submergence.
- When washing the instrument, avoid spraying it with a high pressure stream of water from a water hose. The inside of the instrument will be damaged by the water.
- Be sure to charge the battery within the charging temperature range. Charging temperature range: 10 to 40°C
- Battery is an expendable item. The decline in retained capacity depending on the repeated charging/discharging cycle is out of warranty.
- Affection of the radio waves
When using the instrument in the following place, the strong radio wave may cause faulty operation.
 - Near the instrument occurring strong radio waves. (e.g. Transceiver)
 - Near the radio wave towers such as television or radio.
- When transporting the instrument, provide some protection to minimize risk of shock. Heavy shock may affect beam accuracy.
- In addition to the laser beam emitted from the rotating laser, the laser sensor may be sensitive to smartphone screens, LED lamps, fluorescent lamps, construction lamps, and other modulated lights. In this case, turn off these modulated lights that may be the cause, or block them before performing measurement.
- If an object (glass window, car windshield, etc.) that may reflect a laser beam is close to this instrument, the laser sensor may malfunction. When using this instrument, block the laser beam to the direction of a reflective object.

Examples of malfunctions:

- The display shows "●●●●" even though the location is not a datum position.
- Errors occur for the datum position.
- The display does not show "●●●●" even though the location is a datum position.
- Be sure that the laser emitting window of this instrument, and the beam receiving window of the laser sensor are free from dirt (oil, water droplets, etc.). The measurement result may be in error if these windows are dirty.

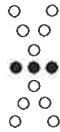

PRECAUTIONS FOR SAFE OPERATION

For the safe use of the product and prevention of injury to operators and other persons as well as prevention of property damage, items which should be observed are indicated by an exclamation point within a triangle used with WARNING and CAUTION statements in this operator's manual.

The definitions of the indications are listed below. Be sure you understand them before reading the manual's main text.

DEFINITION OF INDICATION

	WARNING Ignoring this indication and making an operation error could possibly result in death or serious injury to the operator.
	CAUTION Ignoring this indication and making an operation error could possibly result in personal injury or property damage.

- This symbol indicates items for which caution (hazard warnings inclusive) is urged. Specific details are printed in or near the symbol.
- This symbol indicates items which are prohibited. Specific details are printed in or near the symbol.
- This symbol indicates items which must always be performed. Specific details are printed in or near the symbol.

WARNING

- There is a risk of fire, electric shock or physical harm if you attempt to disassemble or repair the instrument yourself.
This is only to be carried out by TOPCON or an authorized dealer, only!
- Risk of fire or electric shock.
Do not use damaged power cable, plug and socket.
- Risk of fire or electric shock.
Do not use a wet battery.
- May ignite explosively.
Never use an instrument near flammable gas, liquid matter, and do not use in a coal mine.
- Battery can cause explosion or injury.
Do not dispose in fire or heat.
- To prevent shorting of the dry battery in storage, apply insulating tape or equivalent to the terminals. Otherwise shorting could occur, resulting in fire or burns.
- Battery can cause explosion or injury.
Remove battery when using the connector for external power supply.

CAUTION

- Do not touch liquid leaking from dry batteries. Harmful chemicals could cause burns or blisters.

STANDARD PACKAGE COMPONENTS

- LS-B200 Instrument 1pc.
- Carrying case 1pc.
- Instruction manual 1pc.
- Dry battery type***
 - Battery holder DB-83 1pc.
 - Dry batteries(4 x C) are sold separately.

*In some destinations, a rechargeable battery is already set in the main unit.
Rechargeable battery type (Optional accessories)

- Ni-MH battery pack BT-83Q 1pc.
- AC/DC converter AD-11 1pc.



PARTS OF THE INSTRUMENT AND FUNCTIONS

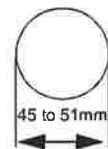
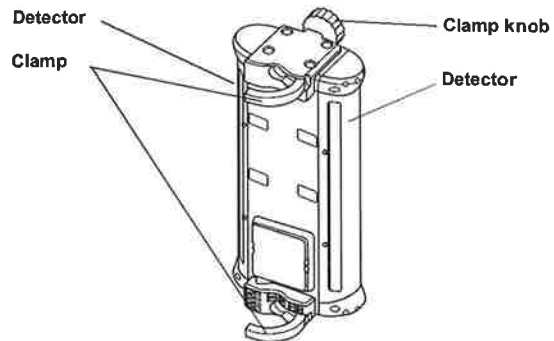
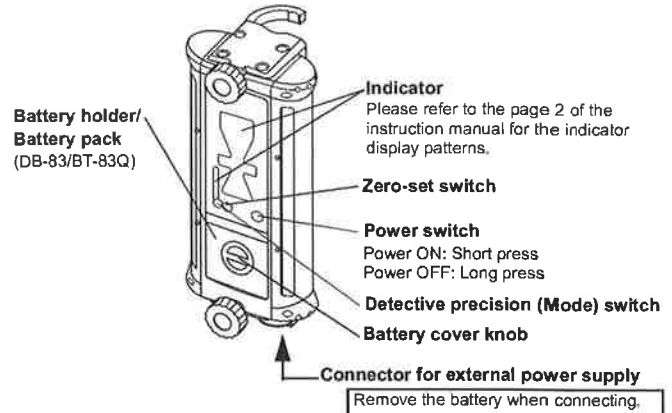

Pipes that can be installed onto the LS-B200 are as described below.

Shape: Cylindrical
Dimension: 45 to 51mm in diameter
Please refer to the instruction manual for the machine or contact the machine manufacturer for instructions on installing the mast onto the machine (by welding, etc.).

REPLACING THE BATTERY

Dry battery

- Remove the DB-83 battery holder by turning the battery cover knob.
- Remove the old batteries and replace with new ones.

Rechargeable battery

- Remove the BT-83Q by turning the battery cover knob.
- Attach the charged BT-83Q to the LS-B200.
- Attach the battery cover by turning the battery cover knob.

- Batteries generate power using a chemical reaction and as a result have a limited life-time. Even when in storage and not used for long periods, battery capacity deteriorates with the passage of time. This may result in the operating time of the battery shortening despite having been charged correctly. In this event, a new battery is required.

OPERATION

- Position a rotating laser and turn on the laser.
- Raise or lower the machine blade or arm to position the cutting edge or bucket at the desired grade elevation.
- Mount the LS-B200 onto the mast near the path of the laser beam and turn on the LS-B200.
- Keep the machine blade or arm motionless and raise or lower the LS-B200 and adjust until ON-GRADE position are blinking. This is the ON GRADE position.
- Securely clamp the LS-B200 in place. The reference position has been set.
- While operating, use the LED display to continually check grade, moving the blade or cutting / filling according to the direction of the LS-B200 display.

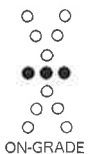

INDICATOR

Precision mode

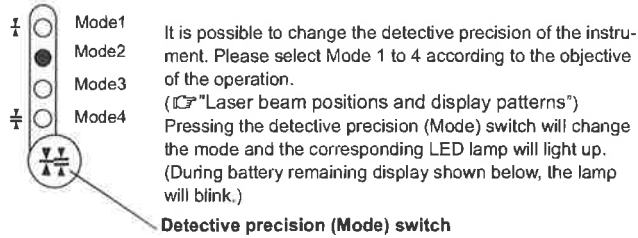

LS-B200 Battery remaining display

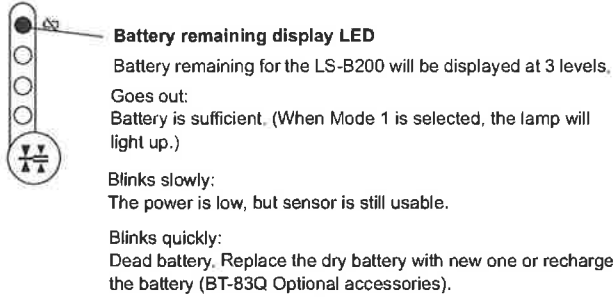

Rotating laser battery warning display

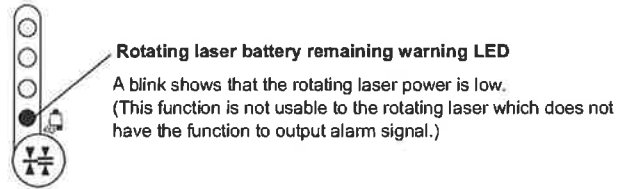

Laser beam positions and display patterns

Indicator (LED)	Detective precision
	Mode1: $\pm 3\text{mm}$ (0.009ft) Mode2: $\pm 6\text{mm}$ (0.019ft) Mode3: $\pm 15\text{mm}$ (0.049ft) Mode4: $\pm 30\text{mm}$ (0.098ft)
<p>Blinks quickly</p>	$\pm 50\text{mm}/\pm 0.16\text{ft}$ (100mm/0.32ft width)
<p>Blinks slowly</p>	$\pm 87.5\text{mm}/\pm 0.28\text{ft}$ (175mm/0.57ft width)
<p>Blinks more slowly</p>	When the laser beam is off to the top or to the bottom

Height alert warning of rotating laser

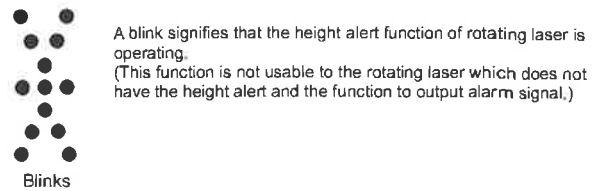

Power-save function(Effective only when using the internal battery)

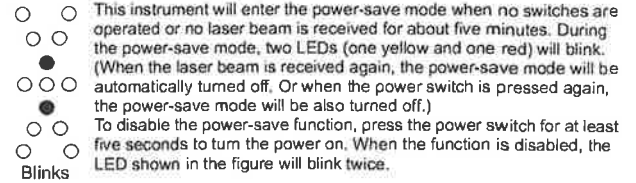

Auto-cut off function(Effective only when using the internal battery)

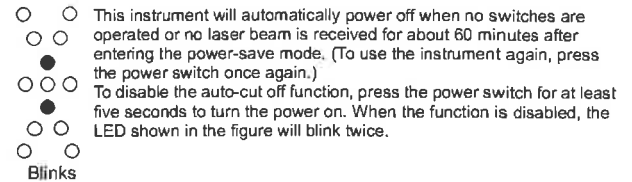

LED brightness adjustment function

(Effective only when using the internal battery)

This instrument detects the ambient brightness and automatically adjusts the LED brightness (high/low). If you want to keep the LED brightness high, turn the power switch on while holding down the detective precision (Mode) switch.

CHANGING THE ON-GRADE POSITION FUNCTION

The ON-GRADE position can be changed to the position where laser beam is detected. Using this function when installing the LS-B200 on the pole of the machine allows easy setting of the height at which the ON-GRADE will be displayed on the LS-B200. The range in which the ON-GRADE position can be changed is $\pm 50\text{mm}$ (total of 100mm) from the center of the detective range.

In order to set the ON-GRADE position at high precision, set it while the laser beam is stable. When setting the ON-GRADE position while the laser beam is unstable (when using at a long-distance - more than 150m - or when atmospheric condition is unstable due to air shimmering or other conditions), the sensor will automatically detect it and the LED indicating the failure will be displayed while changing the ON-GRADE position.

Setting the ON-GRADE position change

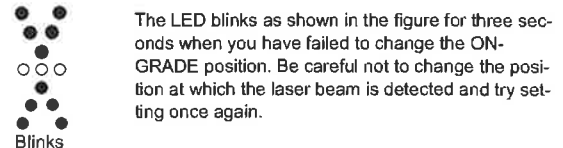
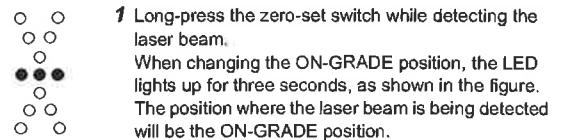

The LED display while changing the ON-GRADE position

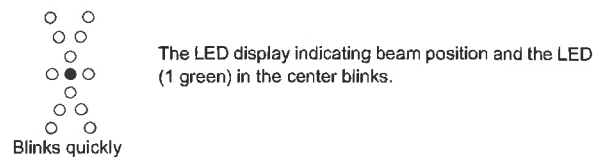

Canceling the ON-GRADE position change

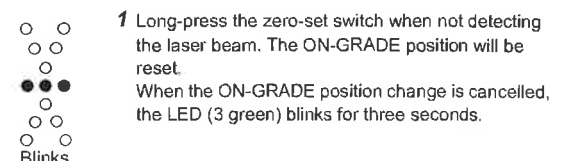

CONNECTOR FOR EXTERNAL POWER SUPPLY

Connecting the connector cable PC-18 (sold separately) to the connector for external power supply will enable the use of the LS-B200 from an external power supply. The LS-B200 will turn on when connection is made to external power supply. The power switch of the instrument will not function when an external power supply is used.

When the instrument is operated with the external power supply, the power-save and the auto-cut off functions will be invalidated.

EXCEPTIONS FROM RESPONSIBILITY

- The manufacturer, or its representatives, assumes no responsibility for any damage, or loss of profits (change of data, loss of data, loss of profits, an interruption of business etc.) caused by use of the product or an unusable product.
- The manufacturer, or its representatives, assumes no responsibility for any damage, or loss of profits caused by usage different to that explained in this manual.
- The manufacturer, or its representatives, assumes no responsibility for consequential damage, or loss of profits due to heavy rain, strong wind, high-temperature and humidity, or storing or use of the product under unusual conditions.
- Product failures caused by rebuilding are out of warranty.
- Cautions and warnings included in this manual do not cover all the possible events.

REGULATIONS

[U.S.A.] FCC Compliance (FCC-Class B)

WARNING:

Changes or modifications to this unit not expressly approved by the party responsible for compliance could void the user's authority to operate the equipment.

NOTE:

This equipment has been tested and found to comply with limits for a Class B digital device, pursuant to Part 15 of the FCC Rules. These limits are designed to provide reasonable protection against harmful interference in a residential installation. This equipment generates, uses, and can radiate radio frequency energy and, if not installed and used in accordance with the instructions, may cause harmful interference to radio communications.

However, there is no guarantee that interference will not occur in a particular installation. If this equipment does cause harmful interference to radio or television reception, which can be determined by turning the equipment off and on, the user is encouraged to try to correct the interference by one or more of the following measures:

- Reorient or relocate the receiving antenna.
- Increase the separation between the equipment and receiver.
- Connect the equipment into an outlet on a circuit different from that to which the receiver is connected.
- Consult the dealer or an experienced radio / TV technician for help.

Means of conformity

This transmitter must not be co-located or operated in conjunction with any other antenna or transmitter.

This equipment complies with FCC radiation exposure limits set forth for an uncontrolled environment and meets the FCC radio frequency (RF) Exposure Guidelines. This equipment has very low levels of RF energy that is deemed to comply without maximum permissive exposure evaluation (MPE). But it is desirable that it should be installed and operated keeping the radiator at least 20cm or more away from person's body.

[California, U.S.A.] Proposition 65

WARNING:

This product can expose you to chemicals including Lead, which is known to the State of California to cause birth defects or other reproductive harm.
For more information go to www.P65Warnings.ca.gov.

[California and NY, U.S.A.] Recycling Batteries

DON'T THROW AWAY RECHARGEABLE BATTERIES, RECYCLE THEM.

Topcon Positioning Systems Inc., United States Return Process for Used Rechargeable Nickel Metal Hydride, Nickel Cadmium, Small Sealed Lead Acid, and Lithium Ion, Batteries

In the United States Topcon Positioning Systems Inc., has established a process by which Topcon customers may return used rechargeable Nickel Metal Hydride(Ni-MH), Nickel Cadmium(Ni-Cd), Small Sealed Lead Acid(Pb), and Lithium Ion(Li-Ion) batteries to Topcon for proper recycling and disposal. Only Topcon batteries will be accepted in this process.

Proper shipping requires that batteries or battery packs must be intact and show no signs of leaking. The metal terminals on the individual batteries must be covered with tape to prevent short circuiting and heat buildup or batteries can be placed in individual plastic bag. Battery packs should not be disassembled prior to return.

Topcon customers are responsible for complying with all federal, state, and local regulations pertaining to packing, labeling, and shipping of batteries. Packages must include a completed return address, be prepaid by the shipper, and travel by surface mode. **Under no circumstance should used/recyclable batteries be shipped by air.**

Failure to comply with the above requirements will result in the rejection of the package at the shipper's expense.

Please remit packages to: Topcon Positioning Systems, Inc.
C/O Battery Return Dept. 150
7400 National Dr.
Livermore, CA 94551

DON'T THROW AWAY RECHARGEABLE BATTERIES, RECYCLE THEM.

[Canada] ICES (ICES-Class B)

This class B digital apparatus meets all requirements of Canadian interference-Causing Equipment Regulations.

Cet appareil numérique de la class B respecte toutes les exigences du Règlement sur le matériel brouilleur du Canada.

This Class B digital apparatus complies with Canadian ICES-003

Cet appareil numérique de la Class B est conforme a la norme NMB-003 du Canada.

This equipment complies with IC radiation exposure limits set forth for an uncontrolled environment and meets the RSS-102 of the IC radio frequency (RF) Exposure Guidelines. This equipment has very low levels of RF energy that is deemed to comply without maximum permissive exposure evaluation (MPE). But it is desirable that it should be installed and operated keeping the radiator at least 20cm or more away from person's body.

[EU/UK] EMC NOTICE (EMC-Class B)

In industrial locations or in proximity to industrial power installations, this instrument might be affected by electromagnetic noise. Under such conditions, please test the instrument performance before use.

This product complies with the electromagnetic environmental testing of industrial locations.

Declaration of conformity is available depending on your request.
Contact your local dealer.

Manufacturer

Name: TOPCON CORPORATION
Address: 75-1, Hasunuma-cho, Itabashi-ku, Tokyo, 174-8580 JAPAN

Europe Representative and Importer

Name: Topcon Europe Positioning B.V.
Address: Essebaan 11, 2908 LJ Capelle a/d IJssel, The Netherlands

UK Importer

Name: Topcon Positioning (Great Britain) Ltd.
Address: Unit 2 Sandy Hill Park, Sandy Way, Tamworth, Staffordshire B77 4DU U.K.

[EU] WEEE Directive

[UK] The Waste Electrical and Electronic Equipment Regulations



The use of the symbol indicates that this product may not be treated as household waste. By ensuring this product is disposed of correctly, you will help prevent potential negative consequences for the environment and human health, which could otherwise be caused by inappropriate waste handling of this product. For more detailed information about the take-back and recycling of this product, please contact your supplier where you purchased the product or consult.

[EU] EU Battery Directive

[UK] The Waste Batteries and Accumulators Regulations 2009

 **Battery users must not dispose of batteries as unsorted general waste, but treat properly.**

If a chemical symbol is printed beneath the symbol shown above, this chemical symbol means that the battery or accumulator contains a heavy metal at a certain concentration. This will be indicated as follows:
 Hg: mercury(0.0005%), Cd: cadmium(0.002%), Pb: lead(0.004%)

These ingredients may be seriously hazardous to human and the global environment.

[China] Chinese Environmental Directive

<产品中有毒物质的名称及含量>

部件名称	有害 物质					
	铅 (Pb)	汞 (Hg)	镉 (Cd)	六价铬 (Cr(VI))	多溴联苯 (PBB)	多溴二苯醚 (PBDE)
主机部位	×	○	×	○	○	○
电源部位	×	○	○	○	○	○
附件	×	○	○	○	○	○
盒子	○	○	○	○	○	○

○：表示该有毒有害物质在该部件所有均质材料中的含量均在电子信息产品中有毒有害物质的限量要求标准规定的限量要求 (GB/T 26572) 以下
 ×：表示该有毒有害物质至少在该部件的某一均质材料中的含量超出电子信息产品中有毒有害物质的限量要求标准规定的限量要求 (GB/T 26572)

This information is applicable for People's Republic of China only.

 环保使用期限标识是根据《电器电子产品有害物质限制使用管理办法》以及《电器电子产品有害物质限制使用标识要求》(SJ/T11364) 制定的, 适用于中国境内销售的电子信息产品的标识。

只要按照安全及使用说明内容在正常使用电子信息产品情况下, 从生产日期算起, 在此期限内产品中含有的有毒有害物质不致发生外泄或突变, 不致对环境造成严重污染或对其人身、财产造成严重损害。产品正常使用后, 废弃并在环保使用年限内或者刚到年限的产品, 请根据国家标准采取适当的方法进行处置。 另外, 此期限不同于质量 / 功能的保证期限。

The Mark and Information are applicable for People's Republic of China only.

SPECIFICATIONS

Detective range	: 175mm (6.8 in) (The range in which the ON-GRADE position can be changed : 100mm)
Detective angle	: 360°
Detective precision	: Mode1: ±3mm (0.009ft) Mode2: ±6mm (0.019ft) Mode3: ±15mm (0.049ft) Mode4: ±30mm (0.098ft)
Detectable laser wave length	: 633 to 785nm
Laser detecting range (diameter)	: 800m (2625ft) (Using RL-200 1S/2S)
Internal battery	: C-size dry cells 4pcs.(sold separately) : Battery pack BT-83Q (sold separately)
External power supply	: DC 10 to 30V
Continuous operating time (20°C/68°F)	: More than 100 hours (Using alkaline dry batteries) : More than 50 hours (Using Battery pack BT-83Q)
Operating temperature	: -20 to 50°C (-4 to 122°F)
Water proof	: IP66 (Based on the standard IEC60529)
Dimensions (W/D/H)	: 158x166x357 (mm) (6.2x6.5x14.0 (in)) (With Mechanical Clamp)
Weight (Without cells)	: 2.2kg (4.8lbs)

Detective angle, Detective precision and Laser detecting range may vary depending on rotating laser being used or atmospheric conditions. Battery using time will vary depending on environmental conditions and operations done with LS-B200.

TOPCON CORPORATION (Manufacturer)

75-1 Hasunuma-cho, Itabashi-ku, Tokyo 174-8580, Japan <https://www.topcon.co.jp>

Please see the following website for contact addresses:

GLOBAL GATEWAY <https://global.topcon.com>

LASER SENSOR LS-B200W

Thank you for purchasing the TOPCON LS-B200W. For the best performance of the instruments, please read these instructions carefully and keep them in a convenient location for future reference.

GENERAL HANDLING PRECAUTIONS

Before starting work or operation, be sure to check that the system is functioning properly.

- Remove the batteries from the instrument when you will not be using it for long period.
- Replace all 4 batteries with new ones at the same time. Do not mix used and new batteries, and do not mix different types of batteries together.
- Use alkaline dry batteries. Nickel hydrogen dry batteries and nickel cadmium dry batteries can be used too, but the operating time is different from the time of alkaline dry batteries.
- Do not submerge the instrument in water.**
- This instrument is designed based on the International Standard IPX 6, but it is not protected from a high pressure water stream or submergence.
- When washing the instrument, avoid spraying it with a high pressure stream of water from a water hose. The inside of the instrument will be damaged by the water.
- Be sure to charge the battery within the charging temperature range. Charging temperature range: 10 to 40°C
- Battery is an expendable item. The decline in retained capacity depending on the repeated charging/discharging cycle is out of warranty.
- Affection of the radio waves

When using the instrument in the following place, the strong radio wave may cause faulty operation.

- Near the instrument occurring strong radio waves. (e.g. Transceiver)
- Near the radio wave towers such as television or radio.
- When transporting the instrument, provide some protection to minimize risk of shock. Heavy shock may affect beam accuracy.
- In addition to the laser beam emitted from the rotating laser, the laser sensor may be sensitive to smartphone screens, LED lamps, fluorescent lamps, construction lamps, and other modulated lights. In this case, turn off these modulated lights that may be the cause, or block them before performing measurement.
- If an object (glass window, car windshield, etc.) that may reflect a laser beam is close to this instrument, the laser sensor may malfunction. When using this instrument, block the laser beam to the direction of a reflective object.

Examples of malfunctions:

- The display shows "●●●●" even though the location is not a datum position.
- Errors occur for the datum position.
- The display does not show "●●●●" even though the location is a datum position.



- Be sure that the laser emitting window of this instrument, and the beam receiving window of the laser sensor are free from dirt (oil, water droplets, etc.). The measurement result may be in error if these windows are dirty.
- Bluetooth Wireless Technology**
 - Bluetooth function may not be built in depending on telecommunications regulations of the country or the area where the instrument is purchased. Contact your local dealer for the details.
 - Use of this technology must be authorized according to telecommunications regulations of the country where the instrument is being used. Contact your local dealer in advance. (☞ "Regulatory Information")
 - TOPCON CORPORATION is not liable for the content of any transmission nor any content related thereto. When communicating important data, run tests beforehand to ascertain that communication is operating normally.
 - Do not divulge the content of any transmission to any third party.
- Radio interference when using Bluetooth technology

Bluetooth communication with the LS-B200W uses the 2.4 GHz frequency band. This is the same band used by the devices described below.

- Industrial, scientific, and medical (ISM) equipment such as microwaves and pacemakers.
- portable premises radio equipment (license required) used in factory production lines etc.
- portable specified low-power radio equipment (license-exempt)
- IEEE802.11b/IEEE802.11g/IEEE802.11n/IEEE802.11ax standard wireless LAN devices.

The above devices use the same frequency band as Bluetooth communications. As a result, using the LS-B200W within proximity to the above devices may result in interference causing communication failure or reduction of transmission speed.

Although a radio station license is not required for this instrument, bear in mind the following points when using Bluetooth technology for communication.

- Do not use the LS-B200W in proximity to microwaves.
- Microwave ovens can cause significant interference resulting in communication failure. Perform communication at a distance of 3m or more from microwave ovens.
- Regarding portable premises radio equipment and portable specified low-power radio equipment:
 - Before starting transmission, check that operation will not take place within the vicinity of portable premises radio equipment or specified low-power radio equipment.
 - In the case that the instrument causes radio interference with portable premises radio equipment, terminate the connection immediately and take measures to prevent further interference (e.g. connect using an interface cable).
 - In the case that the instrument causes radio interference with portable specified low-power radio equipment, contact your local dealer.
- When using Bluetooth function in proximity to IEEE802.11b/IEEE802.11g/IEEE802.11n/IEEE802.11ax standard wireless LAN devices, turn off all devices not being used.
 - Interference may result, causing transmission speed to slow or even disrupting the connection completely. Turn off all devices not being used and vice versa.
- Refrain from using the LS-B200W in proximity to televisions and radios.
 - Televisions and radios use a different frequency band to Bluetooth communications. However, even if the LS-B200W is used within proximity to the above equipment with no adverse effects with regard to Bluetooth communication, moving a Bluetooth compatible device (including the LS-B200W) closer to said equipment may result in electronic noise in sound or images, adversely affecting the performance of televisions and radios.
- Precautions regarding transmission
 - For best results
 - The usable range becomes shorter when obstacles block the line of sight, or devices such as PDAs or computers are used. Wood, glass and plastic will not impede communication but the usable range becomes shorter. Moreover, wood, glass and plastic containing metal frames, plates, foil and other heat shielding elements as well as coatings containing metallic powders may adversely affect wireless communication and concrete, reinforced concrete, and metal will render it impossible.
 - Use a vinyl or plastic cover to protect the instrument from rain and moisture. Metallic materials should not be used.
 - Reduced range due to atmospheric conditions
 - The radio waves used by the LS-B200W may be absorbed or scattered by rain, fog, and moisture from the human body with the limit of usable range becoming lower as a result. Similarly, usable range may also shorten when performing communication in wooded areas. Moreover, as wireless devices lose signal strength when close to the ground, perform communication at as high a position as possible.

TOPCON CORPORATION cannot guarantee full compatibility with all Bluetooth products on the market.

PRECAUTIONS FOR SAFE OPERATION

For the safe use of the product and prevention of injury to operators and other persons as well as prevention of property damage, items which should be observed are indicated by an exclamation point within a triangle used with WARNING and CAUTION statements in this operator's manual. The definitions of the indications are listed below. Be sure you understand them before reading the manual's main text.

DEFINITION OF INDICATION

	WARNING	Ignoring this indication and making an operation error could possibly result in death or serious injury to the operator.
	CAUTION	Ignoring this indication and making an operation error could possibly result in personal injury or property damage.

- This symbol indicates items for which caution (hazard warnings inclusive) is urged. Specific details are printed in or near the symbol.
- This symbol indicates items which are prohibited. Specific details are printed in or near the symbol.
- This symbol indicates items which must always be performed. Specific details are printed in or near the symbol.
- WARNING**
 - There is a risk of fire, electric shock or physical harm if you attempt to disassemble or repair the instrument yourself. This is only to be carried out by TOPCON or an authorized dealer, only!
 - Risk of fire or electric shock. Do not use damaged power cable, plug and socket.
 - Risk of fire or electric shock. Do not use a wet battery.
 - May ignite explosively. Never use an instrument near flammable gas, liquid matter, and do not use in a coal mine.
 - Battery can cause explosion or injury. Do not dispose in fire or heat.
 - To prevent shorting of the dry battery in storage, apply insulating tape or equivalent to the terminals. Otherwise shorting could occur, resulting in fire or burns.
 - Battery can cause explosion or injury. Remove battery when using the connector for external power supply.**
 - Do not use within the vicinity of hospitals. Malfunction of medical equipment could result.
 - Use the instrument at a distance of at least 22 cm from anyone with a cardiac pacemaker. Otherwise, the pacemaker may be adversely affected by the electromagnetic waves produced and cease to operate as normal.
 - Do not use onboard aircraft. The aircraft instrumentation may malfunction as a result.
 - Do not use within the vicinity of automatic doors, fire alarms and other devices with automatic controls as the electromagnetic waves produced may adversely affect operation resulting in an accident.
- CAUTION**
 - Do not touch liquid leaking from dry batteries. Harmful chemicals could cause burns or blisters.

STANDARD PACKAGE COMPONENTS

- LS-B200W Instrument 1pc.
- Carrying case 1pc.
- Instruction manual 1pc.
- Laser Manager Guide 1pc.
- Regulatory Information 1pc.
- Dry battery type***
 - Battery holder DB-83 1pc.
- Dry cell batteries(4 x C) are sold separately.
- *In some destinations, a rechargeable battery is already set in the main unit.
- Rechargeable battery type (Optional accessories)**
 - Ni-MH battery pack BT-83Q 1pc.
 - AC/DC converter AD-11 1pc.



PARTS OF THE INSTRUMENT AND FUNCTIONS

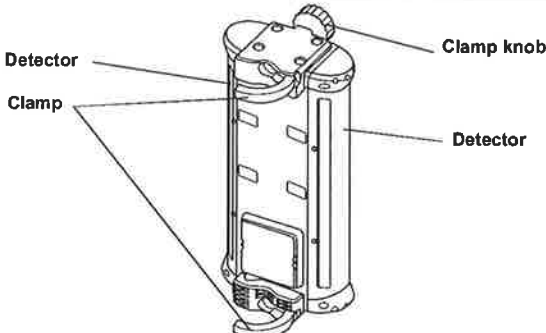
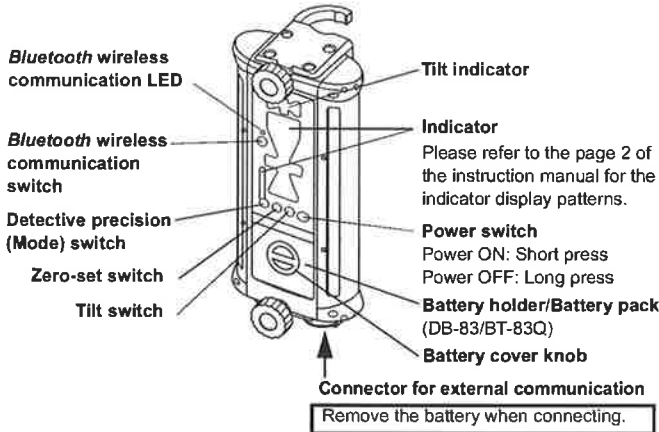

Pipes that can be installed onto the LS-B200W are as described below.

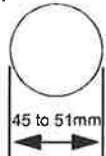

Shape: Cylindrical
Dimension: 45 to 51mm in diameter
Please refer to the instruction manual for the machine or contact the machine manufacturer for instructions on installing the mast onto the machine (by welding, etc.).

REPLACING THE BATTERY

Dry battery

- 1 Remove the DB-83 battery holder by turning the battery cover knob.
- 2 Remove the old batteries and replace with new ones.

Rechargeable battery

- 1 Remove the BT-83Q by turning the battery cover knob.
- 2 Attach the charged BT-83Q to the LS-B200W.
- 3 Attach the battery cover by turning the battery cover knob.



- Batteries generate power using a chemical reaction and as a result have a limited life-time. Even when in storage and not used for long periods, battery capacity deteriorates with the passage of time. This may result in the operating time of the battery shortening despite having been charged correctly. In this event, a new battery is required.

OPERATION

- 1 Position a rotating laser and turn on the laser.
- 2 Raise or lower the machine blade or arm to position the cutting edge or bucket at the desired grade elevation.
- 3 Mount the LS-B200W onto the mast near the path of the laser beam and turn on the LS-B200W.
- 4 Keep the machine blade or arm motionless and raise or lower the LS-B200W and adjust until ON-GRADE position are blinking. This is the ON GRADE position.
- 5 Securely clamp the LS-B200W in place. The reference position has been set.
- 6 While operating, use the LED display to continually check grade, moving the blade or cutting / filling according to the direction of the LS-B200W display.

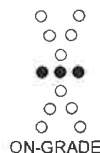

INDICATOR

Precision mode

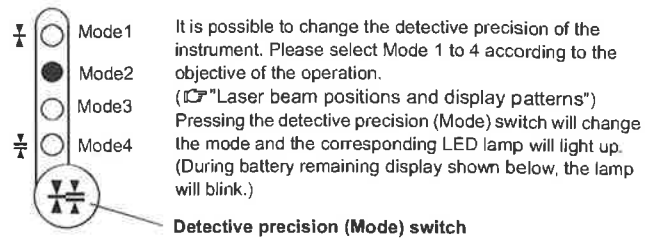

LS-B200W Battery remaining display

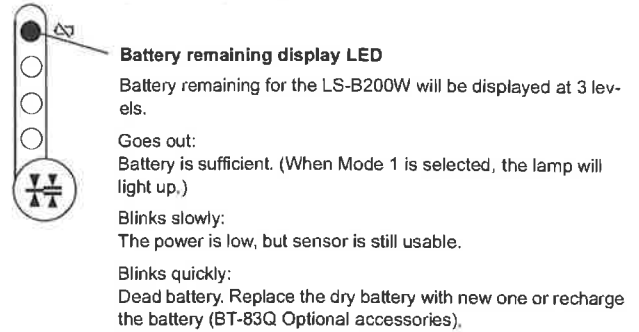

Rotating laser battery warning display

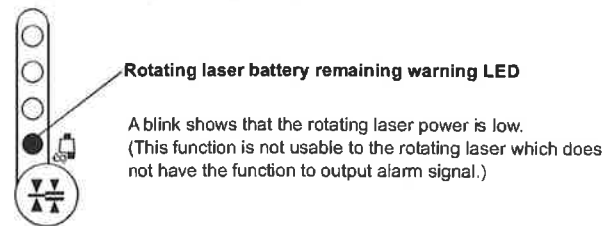

Height alert warning of rotating laser

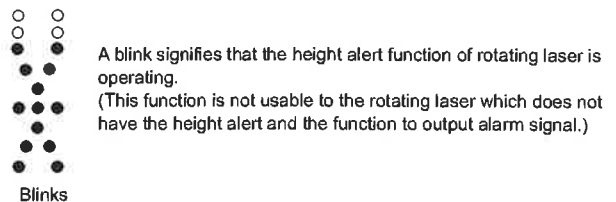

Power-save function (Effective only when using the internal battery)

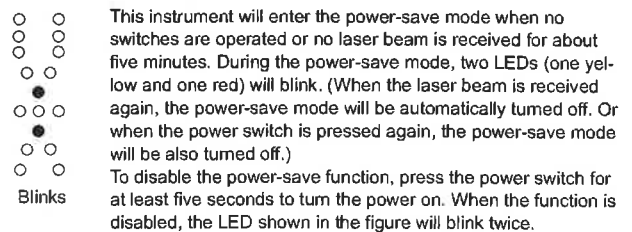

Auto-cut off function (Effective only when using the internal battery)

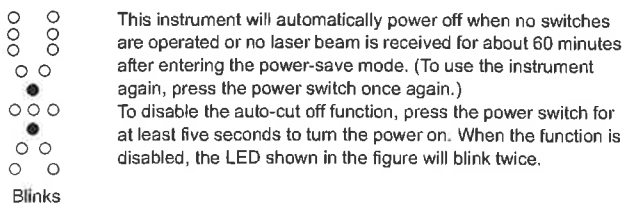

LED brightness adjustment function

(Effective only when using the internal battery)

This instrument detects the ambient brightness and automatically adjusts the LED brightness (high/low). If you want to keep the LED brightness high, turn the power switch on while holding down the detective precision (Mode) switch.

Laser beam positions and display patterns

Indicator (LED)	Detective precision
	Mode1: ±3mm (0.009ft) Mode2: ±6mm (0.019ft) Mode3: ±15mm (0.049ft) Mode4: ±30mm (0.098ft)
	±15mm/±0.05ft (30mm/0.1ft width)
	±30mm/±0.1ft (60mm/0.2ft width)
	±50mm/±0.16ft (100mm/0.33ft width)
	±70mm/±0.23ft (140mm/0.46ft width)
	±125mm/±0.41ft (250mm/0.82ft width)
	When the laser beam is off to the top or to the bottom

TILT DETECTION FUNCTION

Switching the tilt direction

The tilt direction can be changed.

- 1 Long-press the detective precision (Mode) switch and the tilt switch at the same time. The tilt direction mode setting changes in the following order: "Back and Forth," "OFF" and "Right and Left." At this time, the LED at the side of the mark indicating the tilt direction will blink. The LED will not blink when the tilt detection function is switched OFF.

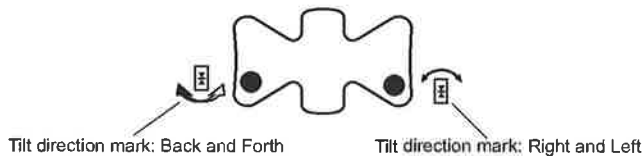

Switching the tilt precision

- 1 Short-press the tilt switch. The tilt precision will change. At this time, the LED at the side of the mark indicating the tilt precision will light up.

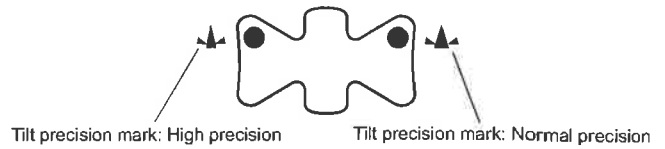

Zero position setting for the tilt sensor

Before using the tilt detection function, set the zero position of the tilt sensor according to the directions below. The tilt direction must be set before setting the zero position.

- 1 Raise or lower the machine blade or arm where the LS-B200W is installed to position the cutting edge or bucket at the desired slope.
- 2 Long-press the tilt switch. The tilt angle for the LS-B200W will set to 0°.

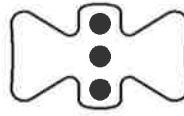

The LED lights up as shown in the figure for three seconds when the zero position is set.



The LED blinks as shown in the figure for three seconds when you have failed to set the zero position.

To set the vertical zero position of tilt sensor to perpendicular.

- 1 Vertically position the machine blade or arm where the LS-B200W is installed.
- 2 Rotate the LS-B200W on the pole each by 90°, and confirm that the green LED in the tilt indicator is blinking in all directions.
- 3 Set the zero position.

TILT ANGLES AND DISPLAY PATTERNS

Tilt directions: Right and Left

	High precision : ±1° Normal precision : ±2.5°
	±5°
	More than ±5°

Tilt directions: Back and Forth

	High precision : ±1° Normal precision : ±2.5°
	High precision : More than ±1° Normal precision : More than ±2.5°

Tilt indication will be displayed during laser detection and for 20 seconds after switch operation.

CHANGING THE ON-GRADE POSITION FUNCTION

The ON-GRADE position can be changed to the position where laser beam is detected. Using this function when installing the LS-B200W on the pole of the machine allows easy setting of the height at which the ON-GRADE will be displayed on the LS-B200W. The range in which the ON-GRADE position can be changed is ±75mm (total of 150mm) from the center of the detective range.

In order to set the ON-GRADE position at high precision, set it while the laser beam is stable. When setting the ON-GRADE position while the laser beam is unstable (when using at a long-distance - more than 150m - or when atmospheric condition is unstable due to air shimmering or other conditions), the sensor will automatically detect it and the LED indicating the failure will be displayed while changing the ON-GRADE position.

Setting the ON-GRADE position change

1 Long-press the zero-set switch while detecting the laser beam.

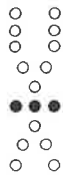

When changing the ON-GRADE position, the LED lights up for three seconds, as shown in the figure. The position where the laser beam is being detected will be the ON-GRADE position.

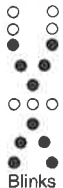

The LED lights up as shown in the figure for three seconds when you have failed to change the ON-GRADE position. Be careful not to change the position at which the laser beam is detected and try setting once again.

Blinks

The LED display while changing the ON-GRADE position

The LED display indicating beam position and the LED (1 green) in the center will blink.



Blinks quickly

Canceling the ON-GRADE position change

1 Long-press the zero-set switch when not detecting the laser beam. The ON-GRADE position will be reset.



When the ON-GRADE position change is cancelled, the LED (3 green) will blink for three seconds.

Blinks

Bluetooth CONNECTION

Using *Bluetooth* communication, LS-B200W can be remotely controlled by devices such as iPhone and Android™.

- *Bluetooth* function may not be built in depending on telecommunications regulations of the country or the area where the instrument is purchased. Contact your local dealer for the details.
- Up to five units of the LS-B200W can be stored for pairing with the controller. If more than five units are paired, they will be deleted in order from oldest to newest.
- When connected with a controller, the connection is held until the time mentioned below.
 - When canceling the connection from the controller; or
 - When pairing is performed with any other controller.
- "Laser Manager" is the name of software used to remotely control and support laser products. It works on devices such as iPhone and Android. The control application "Laser Manager" would be better installed on your controller in advance.
- If LS-B200W is not displayed during the pairing search in Laser Manager, please complete pairing on the OS. After that, please do pairing again by Laser Manager.
- When pairing with some instruments on Laser Manager, *Bluetooth* connection between instrument and Laser Manager may take some time. Please remove unnecessary instruments from *Bluetooth* connection history list on Laser Manager.
- After disconnecting *Bluetooth* by Laser Manager, the instrument icon may not be displayed on the search screen. Please wait for a while and re-enter the *Bluetooth* connection screen again.

Installing laser manager

There are two ways to install Laser Manager:

- Scan the QR code according to the instructions of the included "Laser manager guide".
- Search for "Laser Manager" on the App Store or Google Play. For details on App Store and how to install this application, see the Apple support home page [ICF \(https://support.apple.com\)](https://support.apple.com). For details on Google Play and how to install this application, see the Google support home page [ICF \(https://support.google.com\)](https://support.google.com).

Pairing

- 1 Turn on the LS-B200W.
- 2 Press and hold down the *Bluetooth* wireless communication switch; the *Bluetooth* wireless communication LED will light up/blink as follows.

Lit	Communication initialization in progress
Blinks quickly	While LS-B200W is communicating
Blinks slowly	Communication is in preparation

- 3 With the LED lit, start Laser Manager installed on the controller and search for the *Bluetooth* device.
- 4 Select the LS-B200W you want to connect from the *Bluetooth* devices displayed. The LED will blink rapidly to suggest pairing is completed.

Connecting to a paired controller

- 1 Start Laser Manager.
- 2 Select the LS-B200W you want to connect.
- 3 Connection to the controller is completed; you can remotely control the LS-B200W from the Laser Manager screen.

CONNECTOR FOR EXTERNAL COMMUNICATION

The LS-B200W can be used as the laser detecting sensor for any TOPCON machine control system by connecting the communication cable to the connector for external communication. (Please contact your sales agent for details.)

Connecting the connector cable PC-18 (sold separately) to the connector for external communication will enable the use of the LS-B200W from an external power supply. When the instrument is operated with the external power supply, the power-save and the auto-cut off functions will be invalidated. The LS-B200W will turn on when connection is made to external power supply. The power switch of the instrument will not function when an external power supply is used. Wireless communication will not function when using external communication or an external power supply. *Bluetooth* connection is not available while making external communication and using external power supply.

SPECIFICATIONS

Detective range	: 250mm (9.8 in.) (The range in which the ON-GRADE position can be changed : 150mm)
Detective angle	: 360°
Detective precision	: Mode1: ±3mm (0.009ft) : Mode2: ±6mm (0.019ft) : Mode3: ±15mm (0.049ft) : Mode4: ±30mm (0.098ft)
Detectable laser wave length	: 633 to 785nm
Laser detecting range (diameter)	: 800m (2625ft) (Using the RL-200 1S/2S)
<i>Bluetooth</i> wireless communication*	: <i>Bluetooth</i> 5.0(Low Energy / Classic)
Transmission method	: FHSS
Modulation	: GFSK [Classic(1Mbps) or BLE] : 4-DQPSK [Classic(2Mbps)] : 8-DPSK [Classic(3Mbps)]
Frequency band	: 2.402GHz to 2.480GHz
<i>Bluetooth</i> profile	: SPP, GATT(TOPCON Transfer Service)
Power class	: Class 1
Usable range	: 20m (May vary depending on obstacles between the two instruments as well as other conditions)
Internal battery	: C-size dry batteries 4pcs.(sold separately) : Battery pack BT-83Q (sold separately)
External power supply	: DC 10 to 30V
Continuous operating time* (20°C/68°F)	: More than 80 hours (Using alkaline manganese dry batteries) : More than 40 hours(Using Battery pack BT-83Q) Battery using time will vary depending on environmental conditions and operations done with LS-B200W.
Operating temperature	: -20 to 50°C (-4 to 122°F)
Water proof	: IP66 (Based on the standard IEC60529)
Dimensions (W/D/H)	: 158x166x357 (mm) (6.2x6.5x14.0 (in)) (With Mechanical Clamp)
Weight (Without batteries)	: 2.2kg (4.8lbs)

Detective angle, Detective precision and Laser detecting range may vary depending on rotating laser being used or atmospheric conditions.

EXCEPTIONS FROM RESPONSIBILITY

- The manufacturer, or its representatives, assumes no responsibility for any damage, or loss of profits (change of data, loss of data, loss of profits, an interruption of business etc.) caused by use of the product or an unusable product.
- The manufacturer, or its representatives, assumes no responsibility for any damage, or loss of profits caused by usage different to that explained in this manual.
- The manufacturer, or its representatives, assumes no responsibility for consequential damage, or loss of profits due to heavy rain, strong wind, high-temperature and humidity, or storing or use of the product under unusual conditions.
- Product failures caused by rebuilding are out of warranty.
- Cautions and warnings included in this manual do not cover all the possible events.

[Note]

- App Store is a trademark or a service mark of Apple Inc., registered in the U.S. and other countries.
- iPhone is trademarks of Apple Inc., registered in the U.S. and other countries.
- Android and Google Play are trademarks of Google LLC.
- QR Code is a registered trademark of DENSO WAVE.
- *Bluetooth*® is a registered trademark of Bluetooth SIG, Inc.
- All other company and product names featured in this manual are trademarks or registered trademarks of each respective organization.

TOPCON CORPORATION (Manufacturer)

2541 HIRAKAWA-CHO, BAKURAYAMA, TOKYO 128-8580, JAPAN <https://www.topcon.co.jp>

Please see the following website for contact addresses.

GLOBAL GATEWAY <https://global.topcon.com>

©2022 TOPCON CORPORATION
ALL RIGHTS RESERVED

1054307 -01-A