

Leica NA320/24/32



User Manual



Gebrauchsanweisung



Manuel de l'utilisateur



Manuale d'uso



Manual de uso



Manuel do Utilizador



Handleiding



Brugervejledning



Handbok



دليل المستخدم



Brukerhåndbok



Käyttäjän käsikirja



ユーザーマニュアル



用户手册



사용자 설명서



Instrukcja obsługi



Felhasználói Kézikönyv



Руководство пользователя



Uživatelská příručka



Korisnički priručnik



Εγχειρίδιο Χρήσης



Vartotojo vadovas



Lietotāja rokasgrāmata



Katsutusjuhend



Uporabniški priročnik



Príručka pre používateľov



Kullanma Kilavuzu



Потребителско Ръководство



Manualul utilizatorului

Version 1.0

- when it has to be **right**

Leica
Geosystems

Setting up the tripod
Aufstellen des Stativs
Mise en place du trépied

Colocación del trípode
Mise en place du trépied

004172 001

Careful handling of tripod
Sorgfältige Behandlung des Stativs

Manejo cuidadoso del trípode
Manipulation correcte du trépied

Levelling up
Horizontierung

Nivelación
Calage à l'horizontale

Focusing
Fokussierung

Enfoque
Mise au point

Centering
Zentrierung

Centrado
Centrage

Leica NA320/24/32 User Manual



Version 1.0
English

- when it has to be **right**

Leica
Geosystems

Purchase

Congratulations on the purchase of a Leica NA320/24/32.







This manual contains important safety directions as well as instructions for setting up the product and operating it. Refer to "1 Safety Directions" for further information. Read carefully through the User Manual before you switch on the product.

Product Identification

The type and serial number of your product are indicated on the type plate. Always refer to this information when you need to contact your agency or Leica Geosystems authorised service workshop.

Symbols

The symbols used in this manual have the following meanings:

Type	Description
 DANGER	Indicates an imminently hazardous situation which, if not avoided, will result in death or serious injury.
 WARNING	Indicates a potentially hazardous situation or an unintended use which, if not avoided, could result in death or serious injury.
 CAUTION	Indicates a potentially hazardous situation or an unintended use which, if not avoided, may result in minor or moderate injury.
NOTICE	Indicates a potentially hazardous situation or an unintended use which, if not avoided, may result in appreciable material, financial and environmental damage.
	Important paragraphs which must be adhered to in practice as they enable the product to be used in a technically correct and efficient manner.

Validity of this manual

This manual applies to the NA320/24/32 instruments. Differences between the various models are marked and described.

Available Documentation



Name	Description/Format		
NA320/24/32 User Manual	All instructions required in order to operate the product to a basic level are contained in the User Manual. Provides an overview of the product together with technical data and safety directions.	-	✓

Table of Contents

In this manual	Chapter	Page
1	Safety Directions	4
	1.1 General Introduction	4
	1.2 Definition of Use	4
	1.3 Limits of Use	4
	1.4 Responsibilities	4
	1.5 Hazards of Use	5
2	Description of the System	7
	2.1 Description of the System	7
	2.2 Container Contents	7
	2.3 Instrument Components	8
3	Operation	9
	3.1 Distance and Angle measurement	9
	3.2 Check & Adjust the line of sight	10
4	Care and Transport	11
	4.1 Transport	11
	4.2 Storage	11
	4.3 Cleaning and Drying	11
5	Technical Data	12

1 Safety Directions

1.1 General Introduction

Description The following directions enable the person responsible for the product, and the person who actually uses the equipment, to anticipate and avoid operational hazards.

The person responsible for the product must ensure that all users understand these directions and adhere to them.

1.2 Definition of Use

Intended Use

- Optical height readings.
- Optical distance measuring with stadia readings.

Reasonably foreseeable misuse

- Use of the product without instruction.
- Use outside of the intended use and limits.
- Disabling safety systems.
- Removal of hazard notices.
- Opening the product using tools, for example screwdriver, unless this is permitted for certain functions.
- Modification or conversion of the product.
- Use after misappropriation.
- Use of products with recognisable damages or defects.
- Use with accessories from other manufacturers without the prior explicit approval of Leica Geosystems.
- Aiming directly into the sun.
- Inadequate safeguards at the working site.

1.3 Limits of Use

Environment Suitable for use in an atmosphere appropriate for permanent human habitation: not suitable for use in aggressive or explosive environments.



DANGER

Local safety authorities and safety experts must be contacted before working in hazardous areas, or close to electrical installations or similar situations by the person in charge of the product.

1.4 Responsibilities

Manufacturer of the product Leica Geosystems AG, CH-9435 Heerbrugg, hereinafter referred to as Leica Geosystems, is responsible for supplying the product, including the user manual and original accessories, in a safe condition.

Person responsible for the product The person responsible for the product has the following duties:

- To understand the safety instructions on the product and the instructions in the user manual.
- To ensure that it is used in accordance with the instructions.
- To be familiar with local regulations relating to safety and accident prevention.
- To inform Leica Geosystems immediately if the product and the application becomes unsafe.
- To ensure that the national laws, regulations and conditions for the operation of e.g. radio transmitters or lasers are respected.

**CAUTION**

Watch out for erroneous measurement results if the product has been dropped or has been misused, modified, stored for long periods or transported.

Precautions:

Periodically carry out test measurements and perform the field adjustments indicated in the user manual, particularly after the product has been subjected to abnormal use as well as before and after important measurements.

**DANGER**

Because of the risk of electrocution, it is dangerous to use poles, levelling staffs and extensions in the vicinity of electrical installations such as power cables or electrical railways.

Precautions:

Keep at a safe distance from electrical installations. If it is essential to work in this environment, first contact the safety authorities responsible for the electrical installations and follow their instructions.

**NOTICE**

Strong magnetic fields in the immediate vicinity (e.g. transformers, melting furnaces...) may influence the compensator and lead to measuring errors.

Precautions:

When working near strong magnetic fields, check results for plausibility.

**CAUTION**

Be careful when pointing the product towards the sun, because the telescope functions as a magnifying glass and can injure your eyes and/or cause damage inside the product.

Precautions:

Do not point the product directly at the sun.

**WARNING**

During dynamic applications, for example stakeout procedures there is a danger of accidents occurring if the user does not pay attention to the environmental conditions around, for example obstacles, excavations or traffic.

Precautions:

The person responsible for the product must make all users fully aware of the existing dangers.

**WARNING**

Inadequate securing of the working site can lead to dangerous situations, for example in traffic, on building sites and at industrial installations.

Precautions:

Always ensure that the working site is adequately secured. Adhere to the regulations governing safety, accident prevention and road traffic.

**CAUTION**

If the accessories used with the product are not properly secured and the product is subjected to mechanical shock, for example blows or falling, the product may be damaged or people can sustain injury.

Precautions:

When setting-up the product, make sure that the accessories are correctly adapted, fitted, secured, and locked in position.

Avoid subjecting the product to mechanical stress.

 **WARNING**

If the product is used with accessories, for example masts, staffs, poles, you may increase the risk of being struck by lightning.

Precautions:

Do not use the product in a thunderstorm.

 **WARNING**

If the product is improperly disposed of, the following can happen:

- If polymer parts are burnt, poisonous gases are produced which may impair health.
- If batteries are damaged or are heated strongly, they can explode and cause poisoning, burning, corrosion or environmental contamination.
- By disposing of the product irresponsibly you may enable unauthorised persons to use it in contravention of the regulations, exposing themselves and third parties to the risk of severe injury and rendering the environment liable to contamination.

Precautions:

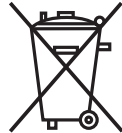

The product must not be disposed with household waste.

Dispose of the product appropriately in accordance with the national regulations in force in your country.

Always prevent access to the product by unauthorised personnel.

Product-specific treatment and waste management information can be downloaded from the Leica Geosystems home page at <http://www.leica-geosystems.com/treatment> or received from your Leica Geosystems distributor.

 **WARNING**

Only Leica Geosystems authorised service workshops are entitled to repair these products.

2 Description of the System

2.1 Description of the System

General description The NA320/24/32 is a modern automatic level for the construction industry. It is a level for all construction levelling and alignment works. Operating this level is simple. Learning is effortless and it works for anyone in your team.

- Easy to use
- Fast set-up with side mirror view at bubble
- Smooth foot-screws for ease of adjustment
- Peep sight for quick line up to target
- Dust and water resistant

Available Models



011147_001

2.2 Container Contents

Container Contents

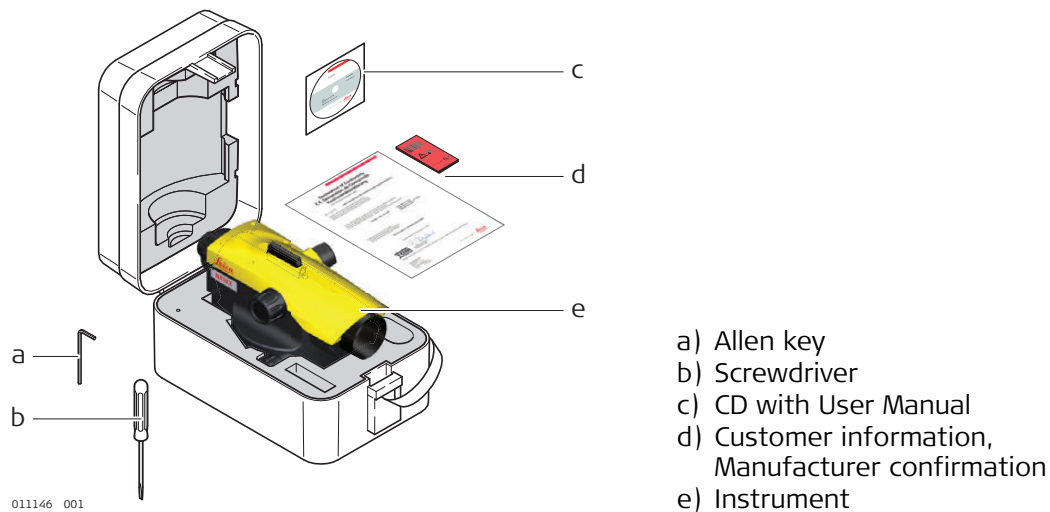

011146_001

Instrument Components

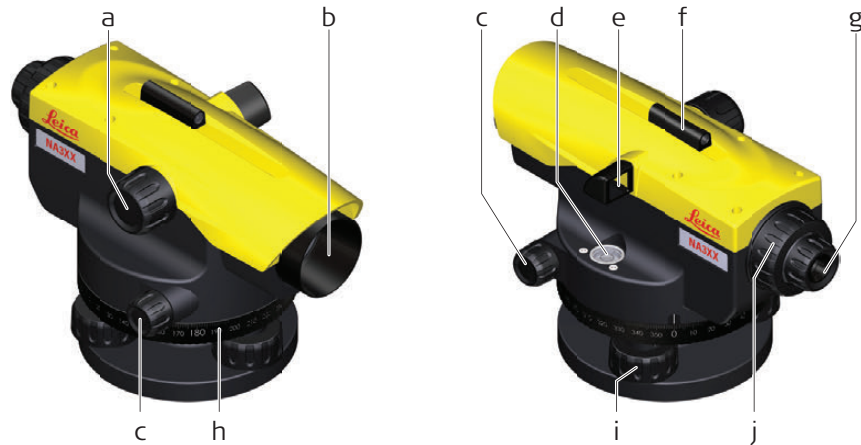

011145.001

- a) Focusing knob
- b) Objective
- c) Endless drive (both sides)
- d) Circular Bubble
- e) Reflecting Mirror

- f) Peep Sight
- g) Eyepiece
- h) Horizontal Circle
- i) Footscrew
- j) Adjustment screw cover

3 Operation

3.1 Distance and Angle measurement

Distance measurement

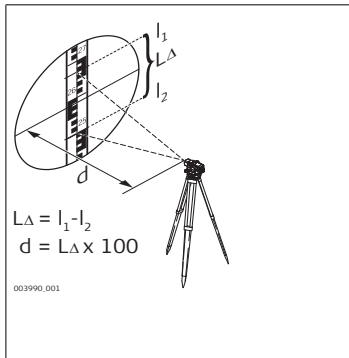

Calculating the distance

Reading	
Upper distance line (l_1):	2.670 m
Lower distance line (l_2):	-2.502 m
Difference L_{Δ} :	0.168 m
	<hr/>
	x 100
	<hr/>
Result	
Distance d:	16.8 m

Distance $d = L_{\Delta} \times 100$

Angle measurement

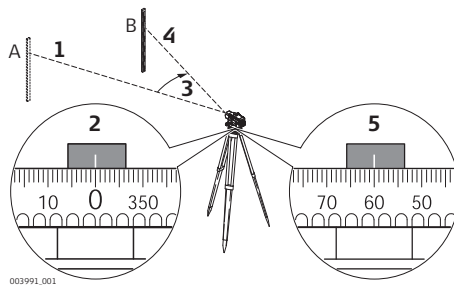

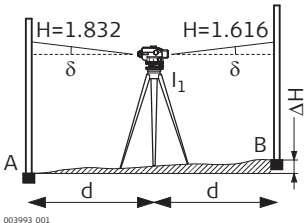
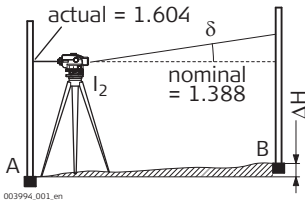

Step	Description
1.	Align instrument to point A.
2.	Turn Hz-circle to "0".
3.	Align instrument to point B.
4.	Aim on the centre of the staff.
5.	Read off Hz-angle from Hz circle. In this example the Hz-angle is 60°.

Checking the line of sight

Step	Description	
	With the circular bubble centred and adjusted, the line of sight should be horizontal.	
1.	Choose a distance of appr. 30 m within a gentle terrain.	
2.	Set up a staff at both final points (A, B).	
3.	Set up the instrument at point I ₁ (halfway between A and B, just pass it down) and centre the bubble.	
4.	Read both staffs. Reading on A = 1.832 m Reading on B = 1.616 m $\Delta H = A - B = 0.216$ m	
5.	Set up the level about 1 m from staff A.	
6.	Read staff A (eg.: 1.604 m).	
7.	Find nominal reading B; eg.: Reading A - $\Delta H = 1.604$ m - 0.216 m = 1.388 m.	
8.	Read staff B, compare nominal-/actual-reading.	

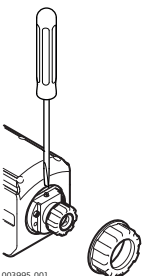
Adjusting the line of sight

Step	Description	
	When the difference nominal-/actual- reading is more than 3 mm the line of sight must be adjusted.	
1.	Turn the adjusting screw until the middle hair gives the required reading (eg. 1.388 m).	
2.	Check line of sight again.	
	Before starting field work or after long periods of storage/ transport of your equipment check the field adjustment parameters specified in this User Manual.	

4 Care and Transport

4.1 Transport

Transport in the field	<p>When transporting the equipment in the field, always make sure that you</p> <ul style="list-style-type: none"> • either carry the product in its original transport container, • or carry the tripod with its legs splayed across your shoulder, keeping the attached product upright.
Transport in a road vehicle	<p>Never carry the product loose in a road vehicle, as it can be affected by shock and vibration. Always carry the product in its transport container, original packaging or equivalent and secure it.</p>
Shipping	<p>When transporting the product by rail, air or sea, always use the complete original Leica Geosystems packaging, transport container and cardboard box, or its equivalent, to protect against shock and vibration.</p>
Field adjustment	<p>Periodically carry out test measurements and perform the field adjustments indicated in the User Manual, particularly after the product has been dropped, stored for long periods or transported.</p>

4.2 Storage

Product	<p>Respect the temperature limits when storing the equipment, particularly in summer if the equipment is inside a vehicle. Refer to "5 Technical Data" for information about temperature limits.</p>
Field adjustment	<p>After long periods of storage inspect the field adjustment parameters given in this user manual before using the product.</p>

4.3 Cleaning and Drying

Product and accessories	<ul style="list-style-type: none"> • Blow dust off lenses. • Never touch the glass with your fingers. • Use only a clean, soft, lint-free cloth for cleaning. If necessary, moisten the cloth with water or pure alcohol. Do not use other liquids; these can attack the polymer components.
Damp products	<p>Dry the product, the transport container, the foam inserts and the accessories at a temperature not greater than +40°C/+104°F and clean them. Do not repack until everything is dry. Always close the transport container when using in the field.</p>

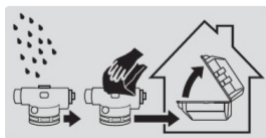

Accuracy	Standard deviation for 1 km double levelling ISO17123-2:	
	NA320:	2.5 mm
	NA324:	2.0 mm
	NA332:	1.8 mm

Telescope	Erect image	
	Magnification	
	NA320:	20 x
	NA324:	24 x
	NA332:	32 x
	Field of view:	< 2.1 m at 100 m
Shortest target distance from instrument axis:	< 1.0 m	

Compensator	Working range:	±15'
	Setting accuracy (standard deviation):	0.5"

Distance measurement	Multiplication factor:	100
	Additive constant:	0

Circular level	Sensitivity:	8'/2 mm
-----------------------	--------------	---------

Circle	Graduation:	360°
	Graduation interval:	1°

Adaption	To normal or ball head tripod	
	Central fixing screw:	5/8"

Environmental specifications**Temperature**

Operating temperature	Storage temperature
-20°C to +40°C (-4°F to +102°F)	-30°C to +55°C (-22°F to +131°F)

Protection against water, dust and sand

Protection
IP54 (IEC 60529)