

GL700 Series Laser Transmitter

Quick Reference Guide

This guide describes the features and functions of the GL700 Series Laser Transmitter. It covers the following topics:

- Laser
- Two-way radio remote control
- Accessories
- How to use the laser system

Corporate Office

Trimble Geomatics and
Engineering Division
5475 Kellenburger Road,
Dayton, Ohio 45424-1099,
U.S.A.

800-538-7800 (Toll Free in U.S.A.)
+1-937-233-8921 Phone
+1-937-233-9004 Fax
www.trimble.com

Copyright and Trademarks

Copyright © 2002–2003, Trimble
Navigation Limited. All rights reserved.

Trimble, and the Globe & Triangle logo, are
trademarks of Trimble Navigation Limited,
registered in the United States Patent and
Trademark Office. Spectra Precision is a
trademark of Trimble Navigation Limited.
All other trademarks are the property of
their respective owners.

Release Notice

This is the November 2003 release
Revision B of the GL700 Series Laser
Transmitter Quick Reference Guide, Part
Number 1445-0730. It applies to version
3.75 of the GL700 Series Laser Transmitter.

Safety Information

For safety information regarding the use
of this laser transmitter, refer to the
*GL700 Series Laser Transmitter User
Guide*.

Laser

- 1 Power button (Ⓜ) – turns the laser on/off.
- 2 Status LED – shows the status of various conditions including an internal, electronic, or a mechanical error (solid red), low-battery (flashing yellow), manual mode (flashing red), HI alert (fast flashing red), and out-of-level (flashing green).
- 3 Manual button (Ⓜ) – changes the laser from automatic self-leveling to manual mode.
- 4 \swarrow Axis Up (⬆) and Down (⬇) buttons – changes the grade for the \swarrow axis.

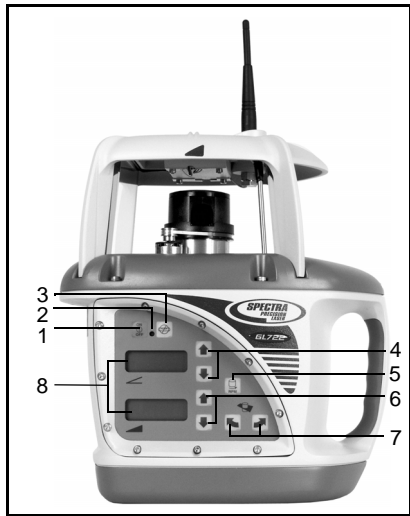

- 5 Rotation-Control button (Ⓜ) – changes the laser beam's rotation speed (300, 600, and 900 rpm).
- 6 \swarrow Axis Up (⬆) and Down (⬇) buttons (dual-grade laser only) – changes the grade for the \swarrow axis.
- 7 Axis-Alignment buttons – rotates the grade axis clockwise (Ⓜ) / counterclockwise (Ⓜ). Rotating the grade axis simulates turning the laser on its tripod, with fine adjustment capability.
- 8 Liquid Crystal Displays (LCDs) – shows the percentage of grade, approximate charge of the batteries, beam's rotation speed, and axis alignment (if other than zero). The single-grade laser has one LCD.

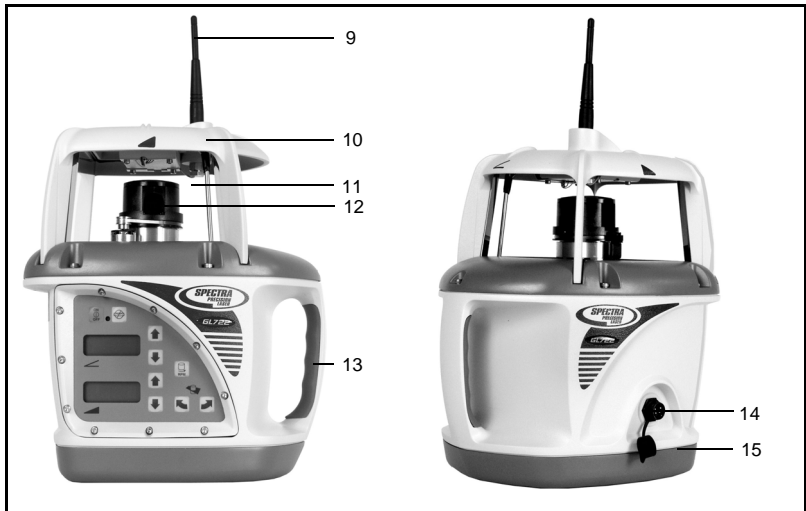

Figure 2.1 Laser transmitter – front and back

-
- 9 Antenna (for radio remote-control lasers only) – sends and receives signals to and from the remote control.
-
- 10 Sunshade – protects the lighthouse from the environment.
-
- 11 Lighthouse – is the 360° exit window for the laser beam. The lighthouse is sealed and protects the internal components from the environment.
-
- 12 Rotor – contains the rotating laser beam.
-
- 13 Handle – allows you to carry the laser easily.
-
- 14 Battery Recharging Receptacle – is the 4-pin receptacle that the battery recharger plugs into. It is also used for external power.
-
- 15 Battery Housing – holds six D-cell Ni-Cd, Ni-MH, or backup alkaline batteries.
-

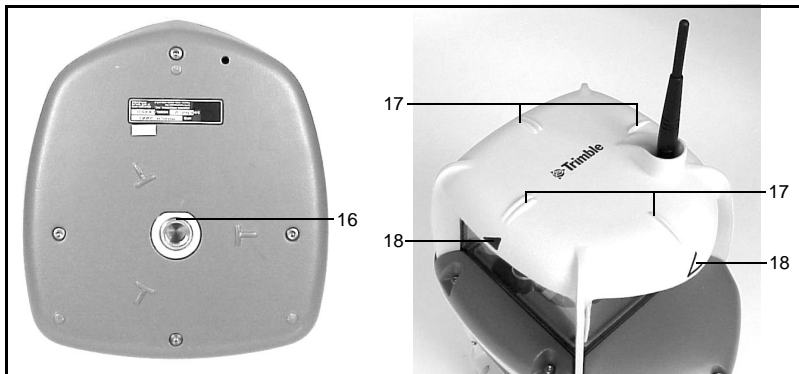

Figure 2.2 Laser transmitter – base and top

-
- 16 5/8-11 Tripod Mount – allows the laser to be connected to a standard 5/8-11 tripod or column mount.
-
- 17 Sighting Guides – are used to visually align the laser with a directional hub or grade stake.
-
- 18 Axis-Alignment Marks – correspond with both laser axes and are used to align the laser in the correct grade direction.
-

Two-Way Radio Remote Control

(Radio equipped lasers only)

-
- 1 Power/Standby button (Ⓜ) – turns the remote control on/off and activates/deactivates standby mode.

 - 2 Manual button (Ⓜ) – changes the laser from automatic self-leveling to manual mode.

 - 3 Mode button (Ⓜ) – allows you to choose the laser’s operational mode, which includes grade change, automatic axis alignment, grade matching, PlaneLok, grade reverse, and beam rotation speed.

 - 4 Up (↑) and Down (↓) buttons – increase/decrease the grade for the ↙ and ↘ axes and increase/decrease the laser beam’s rotation speed. When the laser is in manual mode, these buttons can also be used to increase/decrease the slope of the laser beam.

 - 5 Left (←) and Right (→) buttons – increase/decrease the slope of the ↗ axis when the laser is in manual mode.

 - 6 Liquid Crystal Display (LCD) – shows the mode messages, beam’s rotation speed, and percentage of grade.

 - 7 Enter/Backlight button (Ⓜ) – is a multifunctional button that confirms the selection made from the laser’s operational mode and activates the backlighting function.

 - 8 Antenna – transfers signals between the radio remote control and laser.

 - 9 Remote port contacts – transfers operation and elevation information between the remote control and the receiver.

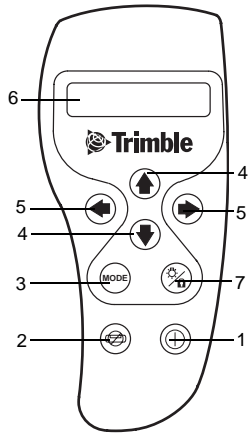

-
- 10 Mounting clip – allows the remote control to be connected to a grade-rod holster, belt, or a screw on a wall.
-
- 11 Battery Housing – holds two AA alkaline batteries.

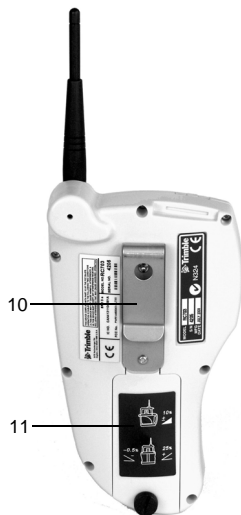

Accessories

Connector cable

- 1 Mounting guides – fit into the mounting channels on the receiver or the radio remote control.

 - 2 Contacts – transfer grade-display signals between the hand-held receiver and radio remote control.

 - 3 Clamp – connects to the receiver so signals can be transferred between the receiver and the radio remote control.

 - 4 4 m (12-ft) cable – transfers signals between the radio remote control and a hand-held receiver.

 - 5 Clamp – connects to the radio remote control so signals can be transferred between the receiver and the radio remote control.
To install:
 1. Put the small key of the clamp into the guide on the back of the radio remote control.
 2. Clip the top part of the clamp into the guide on the front of the radio remote control.
-

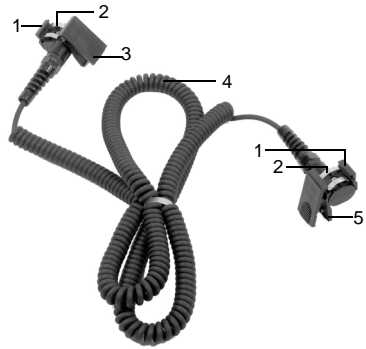

Remote holster

- 1 Mounting slot – provides an opening for the radio remote control clip to be slipped into.
 - 2 Mounting strap – allows the radio remote control to be connected to the grade rod for automatic alignment functions. The holes in the strap accommodate grade rods of varying sizes.
-

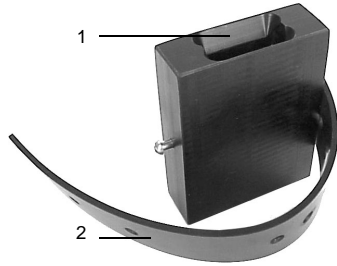

Battery recharger

- 1 4-socket plug with retaining collar – connects to the 4-pin receptacle on the laser.
 - 2 Grounded receptacle – connects to the supplied grounded electrical power cord.
-



External power cable

- 1 Alligator clips (+ and –) – connect to the positive (+) and negative (–) terminals on a 12-V DC battery.
- 2 4-pin plug – connects to the 4-pin receptacle on the laser.

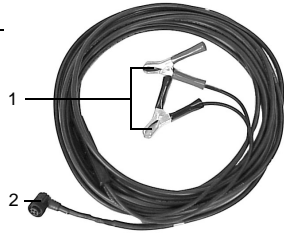

M100 3½-8 Adapter

The 3½-8 adapter allows you to connect the laser which has a 5/8-11 threaded mount to a tripod or other mounting device that has a 3½-8 threaded mount.

M102 Quick-disconnect adapter

The quick-disconnect adapter allows you to quickly disconnect the laser from the tripod.

M103 Steep-grade adapter

The steep-grade adapter allows the internal leveling mechanism of the steep-grade laser to level the laser at grades greater than 25%.

1243 Sighting scope (GL710 and GL720 only)

The sighting scope allows manual alignment of the grade axis to a known reference point. This scope is not required for a radio remote-control laser.

How to Use the Laser System

Powering the laser

Batteries

Depending on the laser system configuration that you purchase, the laser is shipped with either rechargeable nickel-cadmium (Ni-Cd) or nickel/metal-hydride (Ni-MH) batteries.

Temperature affects battery-charging time. For the best results, charge the batteries when the ambient temperature is in the range from 10 °C to 40 °C (50 °F to 104 °F). Charging at a higher temperature may damage the batteries. Charging at a lower temperature may increase the charge time and decrease the charge capacity, resulting in loss of performance and shortened battery-life expectancy.

Even if you buy a laser that uses Ni-Cd batteries, you can upgrade to Ni-MH batteries. Alkaline batteries can also be used as a backup; however, rechargeable batteries should be reinstalled in the laser as soon as possible.

Installing/removing the batteries



Warning – The Ni-CD and Ni-MH batteries may contain small amounts of harmful substances.

- Be sure to charge the battery before using it for the first time, and after not using it for an extended length of time.
 - Charge only with specified chargers, according to device manufacturer's instructions.
 - Do not open the battery, dispose of it in a fire, or short circuit it. These actions may cause the battery to ignite, explode, leak, or get hot, causing personal injury.
 - Dispose in accordance with all applicable federal, state, and local regulations.
 - Keep the battery away from children. If swallowed, do not induce vomiting. Seek medical attention immediately.
-

1. Remove the four screws from the battery housing. Remove the battery housing compartment.
2. Install/remove the batteries.

Note – when installing the batteries, be sure to note the positive (+) and negative (–) diagram inside of the housing.

Note – The laser has reverse voltage polarity protection. If the batteries are put in wrong, no damage occurs to the laser but it does not work. Allow one minute for the laser to recover after the batteries have been installed correctly.

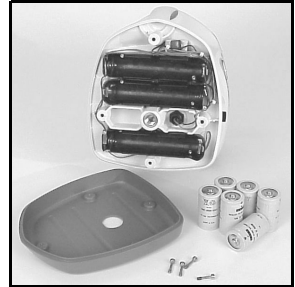

3. Put the battery-housing compartment in place and reinstall the four screws.
To let you know when the batteries are getting low, the status LED flashes. When the status LED flashes yellow, the laser has less than one hour of running time. When the status LED remains on solid yellow, the batteries have less than five minutes running time.

Connecting the laser to a tripod

All lasers have a 5/8-11 tripod mount on the bottom of the laser. Depending on the laser system you purchase, additional mounting adapters may be shipped with your laser. The steep-grade laser system includes a steep-grade adapter.

The laser can also be connected to a standard tripod, column clamp, or other mounting device. If you're using the laser without a tripod, however, make sure you set the laser on a stable surface.

1. Insert the tripod's 5/8-11 screw into the laser's threaded 5/8-11 tripod mount.
2. Turn the screw counterclockwise to hold the laser securely in place.
3. To detach the laser from the tripod, turn the screw clockwise.



Turning on/off the laser

1. Press the power (🔌) button to turn on the laser.

Note – The laser always powers up in the automatic self-leveling mode. If the laser is out of its self-leveling range and remains out of it for more than 10 minutes, the laser shuts down completely.

Note – When the laser is initially turned on, the LCD shows the approximate charge of the batteries, the laser beam's rotation speed, and manual axis-alignment position if it's other than zero. After the LCD shows this information, the last-entered grade immediately appears in the LCD. The status LED flashes green to indicate that the laser is self-leveling. After the laser has self-leveled at the indicated grade, the laser beam rotates and the status LED stops flashing.

Note – After the laser has been level for more than 15 minutes, the HI alert activates. If the laser is disturbed (tripod bumped, etc.) so that when it re-levels the laser beam elevation changes by more than 1/8 in. (3.0 mm), the HI alert shuts down the laser and rotor, and the status LED flashes red two times per second (twice the manual-mode rate).

2. To turn off the laser, press and hold the power button for three seconds.

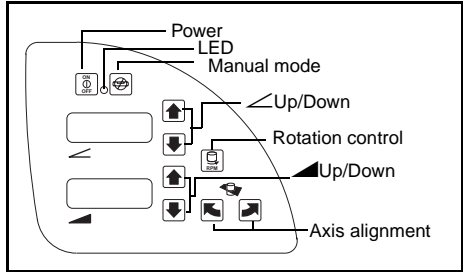

Selecting the rotation speed

The laser has three laser beam rotation speeds—300, 600, and 900 rpm. The rotation speed can be changed at any time to meet your job-site conditions. Use 600 rpm for hand-held receivers and most machine-control systems.

The rotation speed, which can be changed using the radio remote control, appears in the LCD. For more information about using the radio remote control, see the operator's manual.

- Repeatedly press and release the rotation-control button () until the desired rotation speed appears in the LCD.

Note – The selected rotation speed briefly appears in the LCD. After a few seconds, the selected percentage of grade appears in the LCD.

Changing the grade value

The grade value for both axes can be changed using two methods—standard and quick-change. The standard method is used for entering small changes in the grade value. The quick-change method is used for setting grade to zero and entering large changes in the grade value.

The grade value, which can be changed using the radio remote control, appears in the LCD. For more information about using the radio remote control, see the operator's manual.

Standard method

- Press and hold the up or down button for the axis you want to change until the correct grade value appears in the laser's LCD.

Note – The speed of the grade value change increases with the amount of time the button is held down.

Note – Grade values from -0.500 to 9.999% are displayed in thousandths of a percent. Grade values greater than 10% are displayed in hundredths of a percent.

Note – In all models, all changes to the axis-alignment rotation made before you changed the grade value using the standard method are retained.

Quick-change method

Note – The grade value can be quickly set to 0.000% by simultaneously pressing and releasing the up (▲) and down (▼) buttons for the axis you want to change.

1. Simultaneously press and hold the up and down buttons for the axis you want to change to set the grade value to 0.000%.

Note – The grade value for the ▲ axis increases in 1.00% increments. The grade value for the ▼ axis increases in 5.00% increments.

2. Continue pressing and holding the up and down buttons until the correct grade value appears in the laser's LCD.

Note – When the grade value for either axis reaches its highest amount, the grade value switches to the lowest value for that axis. In the ▲ axis, for example, the value switches from +10.00% to -10.00%. In the ▼ axis, the value switches from 25.00% to -0.500%. For steep-grade lasers, the value switches from 110.00% to -0.500%.

Note – On models 722 and 742 only, all changes to the axis-alignment rotation made before you changed the grade value using the quick-change method are cancelled.

Activating/deactivating manual mode

Manual mode bypasses the laser's automatic self-leveling mode so you can use the laser in vertical mode. Manual mode also allows you to tilt the laser beyond its built-in sloping capability so you can perform steep-sloping horizontal applications.



Manual mode can also be activated/deactivated using the radio remote control. The words "Manual Mode" appear in the LCD when manual mode is activated. For more information about using the radio remote control, see the operator's manual.



1. Make sure the laser is on and in the orientation appropriate for your application needs (horizontal or vertical).
2. Press the manual mode button (Ⓜ).

Note – When manual mode is activated, the status LED flashes red once per second and scrolling horizontal segments appear in the laser's LCD.



3. To adjust the laser in the \angle axis so that the laser beam matches the desired slope or grade, use the \angle axis up (⬆) and down (⬇) buttons on the laser or radio remote control.
4. To adjust the laser in the \blacktriangle axis so that the laser beam matches the desired slope or grade, use the \blacktriangle axis up (⬆) and down (⬇) buttons on the laser or the left (⬅) and right (➡) buttons on the radio remote control.
5. To resume automatic self-leveling mode, press the manual button (Ⓜ) on the laser or radio remote control again.

Aligning the axis manually

The manual axis alignment buttons ( ) rotate the grade axis electronically (simulates turning the laser on its tripod, with fine adjustment capability up to a maximum of ± 40 degrees).

1. Set up the laser over a reference point. Make sure the laser is positioned so that the  and  axes are pointing in the right direction.
2. Using the sighting guides as a guide, rotate the laser on its tripod to align the laser to the direction hub.
3. Turn on the laser and allow it to self-level. Set the grade value on both axes to zero.
4. Connect a receiver to a grade rod and turn on the receiver.
5. Set the grade rod on the direction hub and adjust the receiver until you get an on-grade reading.

***Note** – If only one person is manually aligning the laser, use a bipod (commonly used with prism poles) to keep the grade rod plumb when placing it on the direction hub.*

6. Change the grade value on the cross axis, for example, to 4%. Press the appropriate manual axis alignment button to align the laser plane to the receiver. The clockwise axis alignment button () rotates the laser clockwise; the counterclockwise axis alignment button () rotates the laser counterclockwise.
7. Press and hold the axis alignment button until you get an on-grade reading on the receiver again. Then dial the grade value appropriate to your application on one or both axes.

Radio remote control

The radio remote control is a hand-held device that allows you to send operational commands to the laser from a remote location. These operational commands include changing grade values, rotation speed, and operating modes. The radio remote control HAS to be used for the following advanced alignment features:

- Automatic axis alignment
- Grade reverse
- Grade matching
- PlaneLok

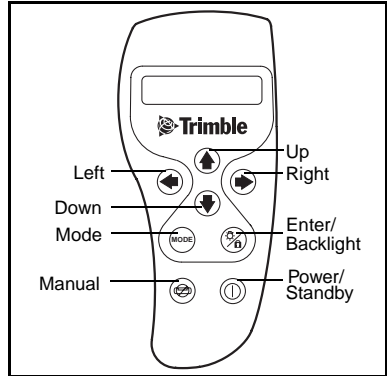

See your operator’s manual for detailed setup and operation of these advanced features.

A solid “T” symbol appears in the right corner of the LCD to indicate that the link between the radio remote control and laser is complete. A flashing bar above the “T” indicates that communication with the laser is established. When the radio remote control is connected to a receiver, an “R” appears in the right corner of the radio remote control’s first display line indicating that a connection has been made and the power is on.

When using the radio remote control, make sure its antenna is pointing skyward. For example, if you’re using the radio remote control in the horizontal position, such as you would when holding the radio remote control in your hand, the antenna should be at a 90° angle to the radio remote control. If you’re using the radio remote control in the vertical position, such as you would when connecting it to a grade rod, the antenna should be sticking up from the top of the radio remote control.

Turning on/off the radio remote control

1. Press the power button (Ⓜ) to turn on the radio remote control.

Note – When the radio remote control is initially turned on, the axes symbols and last-entered grade for each axis appear in the LCD.

2. To turn off the radio remote control, press and hold the power button for 3 seconds.

Selecting the operational mode

The mode button allows you to choose the laser's operational mode, which includes changing grade, automatic axis alignment, grade matching, PlaneLok, grade reverse, and beam rotation speed.

1. Repeatedly press and release the mode button (Ⓜ) to cycle through the operational menu. The menu selections appear in the radio remote control's LCD.
2. Press the enter button (Ⓜ) to confirm your selection.