

# GeoMax Zone20 H

## User Manual

---



Version 1.0  
English

# Introduction

## Purchase

Congratulations on the purchase of a GeoMax Rotating Laser product.



This manual contains important safety directions as well as instructions for setting up the product and operating it. Refer to "1 Safety Directions" for further information. Read carefully through the User Manual before you switch on the product.



## Product Identification

The type and serial number of your product are indicated on the type plate. Always refer to this information when you need to contact your agency or GeoMax authorised service workshop.

## Validity of this manual

This manual applies to the Zone20 H lasers. Differences between the models are marked and described.

## Available documentation

| Name                 | Description/Format   |  |  |
|----------------------|--|---|---|
| Zone20 H Quick Guide | Provides an overview of the product. Intended as a quick reference guide.  | ✓   | ✓   |
| Zone20 H User Manual | All instructions required in order to operate the product to a basic level are contained in the User Manual. Provides an overview of the product together with technical data and safety directions. | -   | ✓   |

### Refer to the following resources for all Zone20 H documentation/software:

- the GeoMax Zone20 H CD
- the GeoMax website: <http://www.geomax-positioning.com>

# Table of Contents

| In this manual | Chapter                             | Page      |
|----------------|-------------------------------------|-----------|
| <b>1</b>       | <b>Safety Directions</b>            | <b>4</b>  |
| 1.1            | General                             | 4         |
| 1.2            | Definition of Use                   | 4         |
| 1.3            | Limits of Use                       | 5         |
| 1.4            | Responsibilities                    | 5         |
| 1.5            | Hazards of Use                      | 5         |
| 1.6            | Laser Classification                | 6         |
|                | 1.6.1 General                       | 6         |
|                | 1.6.2 Zone20 H                      | 7         |
| 1.7            | Electromagnetic Compatibility EMC   | 7         |
| 1.8            | FCC Statement, Applicable in U.S.   | 8         |
| <b>2</b>       | <b>Description of the System</b>    | <b>10</b> |
| 2.1            | System Components                   | 10        |
| 2.2            | Zone20 H Laser Components           | 10        |
| 2.3            | Case Components                     | 11        |
| 2.4            | Setup                               | 11        |
| <b>3</b>       | <b>Operation</b>                    | <b>12</b> |
| 3.1            | Buttons                             | 12        |
| 3.2            | LED Indicators                      | 12        |
| 3.3            | Turning the Zone20 H on and off     | 13        |
| 3.4            | Automatic Mode                      | 13        |
| 3.5            | Manual Mode                         | 13        |
| 3.6            | Elevation Alert (H.I.) Function     | 14        |
| <b>4</b>       | <b>Receivers</b>                    | <b>15</b> |
| 4.1            | ZRB35 Receiver                      | 15        |
| 4.2            | ZRP105 Receiver                     | 16        |
| 4.3            | ZRD105, Digital Receiver            | 17        |
| <b>5</b>       | <b>Applications</b>                 | <b>19</b> |
| 5.1            | Setting Forms                       | 19        |
| 5.2            | Checking Grades                     | 19        |
| 5.3            | Manual Grades                       | 20        |
| <b>6</b>       | <b>Batteries</b>                    | <b>21</b> |
| 6.1            | Operating Principles                | 21        |
| 6.2            | Battery for Zone20 H                | 21        |
| <b>7</b>       | <b>Accuracy Adjustment</b>          | <b>24</b> |
| 7.1            | Checking the Level Accuracy         | 24        |
| 7.2            | Adjusting the Level Accuracy        | 24        |
| <b>8</b>       | <b>Troubleshooting</b>              | <b>26</b> |
| <b>9</b>       | <b>Care and Transport</b>           | <b>28</b> |
| 9.1            | Transport                           | 28        |
| 9.2            | Storage                             | 28        |
| 9.3            | Cleaning and Drying                 | 28        |
| <b>10</b>      | <b>Technical Data</b>               | <b>29</b> |
| 10.1           | Conformity to National Regulations  | 29        |
| 10.2           | Dangerous Goods Regulations         | 29        |
| 10.3           | General Technical Data of the Laser | 29        |

# 1 Safety Directions

## 1.1 General

### Description

The following directions enable the person responsible for the product, and the person who actually uses the equipment, to anticipate and avoid operational hazards.

The person responsible for the product must ensure that all users understand these directions and adhere to them.

### About Warning Messages





Warning messages are an essential part of the safety concept of the instrument. They appear wherever hazards or hazardous situations can occur.

#### Warning messages...

- make the user alert about direct and indirect hazards concerning the use of the product.
- contain general rules of behaviour.

For the users' safety, all safety instructions and safety messages shall be strictly observed and followed! Therefore, the manual must always be available to all persons performing any tasks described herein.

**DANGER, WARNING, CAUTION** and **NOTICE** are standardized signal words for identifying levels of hazards and risks related to personal injury and property damage. For your safety it is important to read and fully understand the table below with the different signal words and their definitions! Supplementary safety information symbols may be placed within a warning message as well as supplementary text.

| Type  | Description   |
|---|---|
|  <b>DANGER</b>   | Indicates an imminently hazardous situation which, if not avoided, will result in death or serious injury.  |
|  <b>WARNING</b>  | Indicates a potentially hazardous situation or an unintended use which, if not avoided, could result in death or serious injury.                                |
|  <b>CAUTION</b> | Indicates a potentially hazardous situation or an unintended use which, if not avoided, may result in minor or moderate injury.                                 |
| <b>NOTICE</b>   | Indicates a potentially hazardous situation or an unintended use which, if not avoided, may result in appreciable material, financial and environmental damage. |
|                | Important paragraphs which must be adhered to in practice as they enable the product to be used in a technically correct and efficient manner.                  |

## 1.2 Definition of Use

### Intended use

- The product casts a horizontal laser plane or a laser beam for the purpose of alignment.
- The laser beam can be detected by means of a laser detector.
- Remote control of product.
- Data communication with external appliances.

### Reasonably foreseeable misuse

- Use of the product without instruction.
- Use outside of the intended use and limits.
- Disabling safety systems.
- Removal of hazard notices.
- Opening the product using tools, for example screwdriver, unless this is permitted for certain functions.
- Modification or conversion of the product.
- Use after misappropriation.
- Use of products with obvious damages or defects.
- Use with accessories from other manufacturers without the prior explicit approval of GeoMax.
- Inadequate safeguards at the working site.
- Deliberate dazzling of third parties.
- Controlling of machines, moving objects or similar monitoring application without additional control and safety installations.

### 1.3 Limits of Use

**Environment** Suitable for use in an atmosphere appropriate for permanent human habitation: not suitable for use in aggressive or explosive environments.

 **DANGER** Local safety authorities and safety experts must be contacted before working in hazardous areas, or close to electrical installations or similar situations by the person in charge of the product.

### 1.4 Responsibilities

**Manufacturer of the product** GeoMax AG, CH-9443 Widnau, hereinafter referred to as GeoMax, is responsible for supplying the product, including the user manual and original accessories, in a safe condition.

**Person responsible for the product** The person responsible for the product has the following duties:

- To understand the safety instructions on the product and the instructions in the user manual.
- To ensure that it is used in accordance with the instructions.
- To be familiar with local regulations relating to safety and accident prevention.
- To inform GeoMax immediately if the product and the application becomes unsafe.
- To ensure that the national laws, regulations and conditions for the operation of e.g. radio transmitters or lasers are respected.

### 1.5 Hazards of Use

 **CAUTION** Watch out for erroneous measurement results if the product has been dropped or has been misused, modified, stored for long periods or transported.

**Precautions:** Periodically carry out test measurements and perform the field adjustments indicated in the user manual, particularly after the product has been subjected to abnormal use as well as before and after important measurements.

 **DANGER** Because of the risk of electrocution, it is dangerous to use poles, levelling staffs and extensions in the vicinity of electrical installations such as power cables or electrical railways.

**Precautions:** Keep at a safe distance from electrical installations. If it is essential to work in this environment, first contact the safety authorities responsible for the electrical installations and follow their instructions.



**NOTICE** With the remote control of products, it is possible that extraneous targets will be picked out and measured.

**Precautions:** When measuring in remote control mode, always check your results for plausibility.

 **WARNING** If the product is used with accessories, for example masts, staffs, poles, you may increase the risk of being struck by lightning.

**Precautions:** Do not use the product in a thunderstorm.

 **WARNING** Inadequate securing of the working site can lead to dangerous situations, for example in traffic, on building sites and at industrial installations.

**Precautions:** Always ensure that the working site is adequately secured. Adhere to the regulations governing safety, accident prevention and road traffic.

 **CAUTION** If the accessories used with the product are not properly secured and the product is subjected to mechanical shock, for example blows or falling, the product may be damaged or people can sustain injury.

**Precautions:** When setting-up the product, make sure that the accessories are correctly adapted, fitted, secured, and locked in position. Avoid subjecting the product to mechanical stress.



|   |  |  |
|---|--|--|
|   | <b>CAUTION</b>   | <p>During the transport, shipping or disposal of batteries it is possible for inappropriate mechanical influences to constitute a fire hazard.</p> <p><b>Precautions:</b><br/>         Before shipping the product or disposing of it, discharge the batteries by running the product until they are flat.<br/>         When transporting or shipping batteries, the person in charge of the product must ensure that the applicable national and international rules and regulations are observed. Before transportation or shipping contact your local passenger or freight transport company.</p>   |
|   | <b>WARNING</b>   | <p>During dynamic applications, for example stakeout procedures there is a danger of accidents occurring if the user does not pay attention to the environmental conditions around, for example obstacles, excavations or traffic.</p> <p><b>Precautions:</b><br/>         The person responsible for the product must make all users fully aware of the existing dangers.</p>   |
|   | <b>WARNING</b>   | <p>If you open the product, either of the following actions may cause you to receive an electric shock.</p> <ul style="list-style-type: none"> <li>• Touching live components</li> <li>• Using the product after incorrect attempts were made to carry out repairs</li> </ul> <p><b>Precautions:</b><br/>         Do not open the product. Only GeoMax authorised service workshops are entitled to repair these products.</p>   |
|   | <b>WARNING</b>   | <p>If the product is improperly disposed of, the following can happen:</p> <ul style="list-style-type: none"> <li>• If polymer parts are burnt, poisonous gases are produced which may impair health.</li> <li>• If batteries are damaged or are heated strongly, they can explode and cause poisoning, burning, corrosion or environmental contamination.</li> <li>• By disposing of the product irresponsibly you may enable unauthorised persons to use it in contravention of the regulations, exposing themselves and third parties to the risk of severe injury and rendering the environment liable to contamination.</li> </ul> <p><b>Precautions:</b></p> |
|   | <p>The product must not be disposed with household waste.<br/>         Dispose of the product appropriately in accordance with the national regulations in force in your country.<br/>         Always prevent access to the product by unauthorised personnel.</p> |  |
| <p>Product-specific treatment and waste management information can be downloaded from the GeoMax website at <a href="http://www.geomax-positioning.com/treatment">http://www.geomax-positioning.com/treatment</a> or received from your GeoMax distributor.</p> |  |  |
|   | <b>WARNING</b>   | <p>Only GeoMax authorised service workshops are entitled to repair these products.</p>   |
|   | <b>WARNING</b>   | <p>High mechanical stress, high ambient temperatures or immersion into fluids can cause leakage, fire or explosions of the batteries.</p> <p><b>Precautions:</b><br/>         Protect the batteries from mechanical influences and high ambient temperatures. Do not drop or immerse batteries into fluids.</p>  |
|   | <b>WARNING</b>   | <p>If battery terminals are short circuited e.g. by coming in contact with jewellery, keys, metalized paper or other metals, the battery can overheat and cause injury or fire, for example by storing or transporting in pockets.</p> <p><b>Precautions:</b><br/>         Make sure that the battery terminals do not come into contact with metallic objects.</p>  |

## 1.6 Laser Classification

### 1.6.1 General

#### General

The following chapters provide instructions and training information about laser safety according to international standard IEC 60825-1 (2014-05) and technical report IEC TR 60825-14 (2004-02). The information enables the person responsible for the product and the person who actually uses the equipment, to anticipate and avoid operational hazards.

-  According to IEC TR 60825-14 (2004-02), products classified as laser class 1, class 2 and class 3R do not require:
- laser safety officer involvement,
  - protective clothes and eyewear,
  - special warning signs in the laser working area
- if used and operated as defined in this User Manual due to the low eye hazard level.
-  National laws and local regulations could impose more stringent instructions for the safe use of lasers than IEC 60825-1 (2014-05) and IEC TR 60825-14 (2004-02).

### 1.6.2 Zone20 H

#### General

The rotating laser built into the product produces a visible laser beam which emerges from the rotating head.

The laser product described in this section is classified as laser class 1 in accordance with:

- IEC 60825-1 (2014-05): "Safety of laser products"

These products are safe for momentary exposures but can be hazardous for deliberate staring into the beam. The beam may cause dazzle, flash-blindness and after-images, particularly under low ambient light conditions.



#### Zone20 H:

| Description                          | Value    |
|--------------------------------------|----------|
| Maximum average radiant output power | 2.6 mW   |
| Pulse duration (effective)           | 1.1 ms   |
| Pulse repetition frequency           | 10 Hz    |
| Beam divergence                      | 0.2 mrad |
| Wavelength                           | 635 nm   |

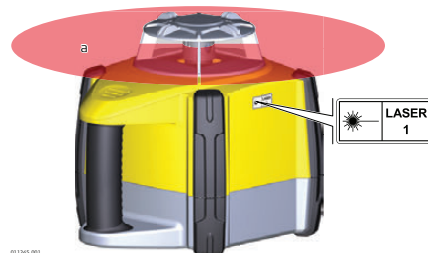
#### Labelling



a) Laser beam

|  |   |
|--|---|
| <b>Description</b>   | The term Electromagnetic Compatibility is taken to mean the capability of the product to function smoothly in an environment where electromagnetic radiation and electrostatic discharges are present, and without causing electromagnetic disturbances to other equipment.   |
|  <b>WARNING</b>   | <p>Electromagnetic radiation can cause disturbances in other equipment.</p> <p>Although the product meets the strict regulations and standards which are in force in this respect, GeoMax cannot completely exclude the possibility that other equipment may be disturbed.</p>  |
|  <b>CAUTION</b>   | <p>There is a risk that disturbances may be caused in other equipment if the product is used with accessories from other manufacturers, for example field computers, personal computers or other electronic equipment, non-standard cables or external batteries.</p> <p><b>Precautions:</b><br/>Use only the equipment and accessories recommended by GeoMax. When combined with the product, they meet the strict requirements stipulated by the guidelines and standards. When using computers or other electronic equipment, pay attention to the information about electromagnetic compatibility provided by the manufacturer.</p>   |
|  <b>CAUTION</b>   | <p>Disturbances caused by electromagnetic radiation can result in erroneous measurements. Although the product meets the strict regulations and standards which are in force in this respect, GeoMax cannot completely exclude the possibility that the product may be disturbed by intense electromagnetic radiation, for example, near radio transmitters, two-way radios or diesel generators.</p> <p><b>Precautions:</b><br/>Check the plausibility of results obtained under these conditions.</p>   |
|  <b>CAUTION</b>   | <p>If the product is operated with connecting cables attached at only one of their two ends, for example external supply cables, interface cables, the permitted level of electromagnetic radiation may be exceeded and the correct functioning of other products may be impaired.</p> <p><b>Precautions:</b><br/>While the product is in use, connecting cables, for example product to external battery, product to computer, must be connected at both ends.</p>   |
| <b>Radios or Digital Cellular Phones</b>   | Use of product with radio or digital cellular phone devices:  |
|  <b>WARNING</b> | <p>Electromagnetic fields can cause disturbances in other equipment, in installations, in medical devices, for example pacemakers or hearing aids and in aircraft. It can also affect humans and animals.</p> <p><b>Precautions:</b><br/>Although the product meets the strict regulations and standards which are in force in this respect, GeoMax cannot completely exclude the possibility that other equipment can be disturbed or that humans or animals can be affected.</p> <ul style="list-style-type: none"> <li>• Do not operate the product with radio or digital cellular phone devices in the vicinity of filling stations or chemical installations, or in other areas where an explosion hazard exists.</li> <li>• Do not operate the product with radio or digital cellular phone devices near to medical equipment.</li> <li>• Do not operate the product with radio or digital cellular phone devices in aircraft.</li> </ul> |

|  |   |
|--|---|
|  <b>WARNING</b> | <p>This equipment has been tested and found to comply with the limits for a Class B digital device, pursuant to part 15 of the FCC rules. These limits are designed to provide reasonable protection against harmful interference in a residential installation.</p> <p>This equipment generates, uses and can radiate radio frequency energy and, if not installed and used in accordance with the instructions, may cause harmful interference to radio communications. However, there is no guarantee that interference will not occur in a particular installation.</p> <p>If this equipment does cause harmful interference to radio or television reception, which can be determined by turning the equipment off and on, the user is encouraged to try to correct the interference by one or more of the following measures:</p> <ul style="list-style-type: none"> <li>• Reorient or relocate the receiving antenna.</li> <li>• Increase the separation between the equipment and the receiver.</li> <li>• Connect the equipment into an outlet on a circuit different from that to which the receiver is connected.</li> <li>• Consult the dealer or an experienced radio/TV technician for help.</li> </ul> |
|--|---|



**WARNING**

Changes or modifications not expressly approved by GeoMax for compliance could void the user's authority to operate the equipment.

**Labelling Zone20 H**



011246.001

**Labelling receiver**

**ZRB35:**

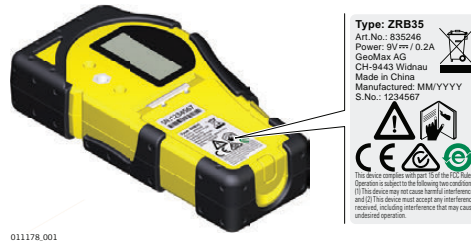

011178.001

**Labelling receiver**

**ZRP105:**

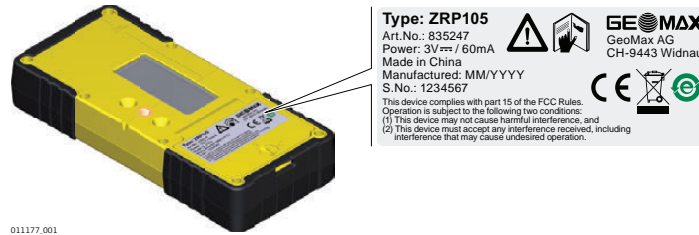

011177.001

**Labelling receiver**

**ZRD105:**

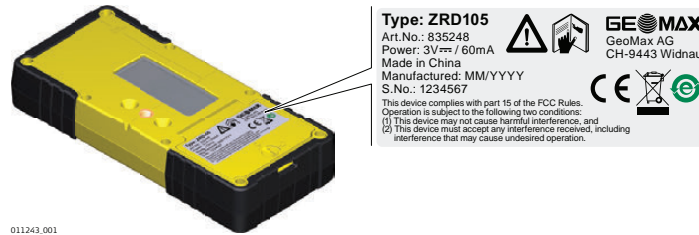

011243.001

## 2 Description of the System

### 2.1 System Components

#### General description

The Zone20 H is a laser tool for general construction and levelling applications such as

- Setting forms
- Checking grades
- Controlling depths for excavations

If set up within the self-levelling range, the Zone20 H automatically levels to create an accurate horizontal plane of laser light.

Once the Zone20 H has levelled, the head will start rotating and the Zone20 H is ready for use.

30 seconds after the Zone20 H has completed the levelling, the H.I. Alert system becomes active and protects the Zone20 H against changes in elevation caused by movement of the tripod to ensure accurate work.

#### Available system components

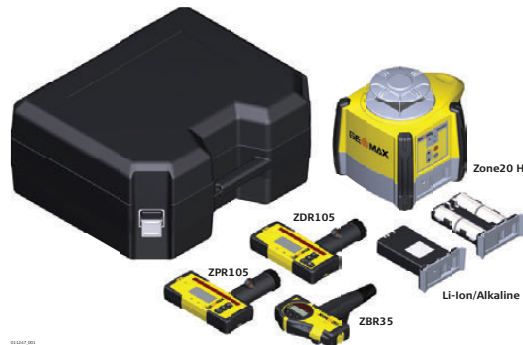

The delivered components depend on the package ordered.

### 2.2 Zone20 H Laser Components

#### Zone20 H laser components



- a) Carry Handle
- b) LED Indicators
- c) Buttons
- d) Battery compartment
- e) Charge LED (for Li-Ion battery pack)

## 2.3

## Case Components

### Case components

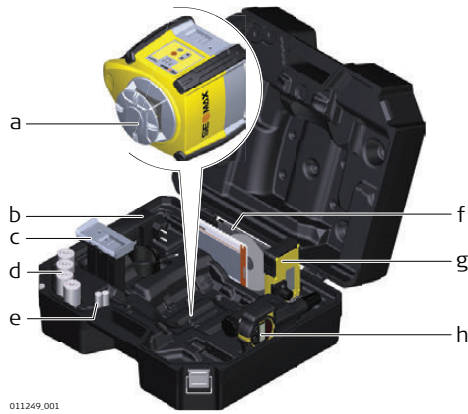

011249.001

- a) Zone20 H laser
- b) Charger (for Li-Ion versions only)
- c) Li-Ion battery pack or Alkaline battery pack
- d) 4 x D-cell battery (for alkaline versions only)
- e) 2x AA-cell battery
- f) User Manual/CD
- g) Receiver mounted on the bracket
- h) Second receiver (can be purchased separately)

## 2.4

## Setup

### Location

- Keep the location clear of possible obstructions that could block or reflect the laser beam.
- Place the Zone20 H on a stable ground. Ground vibration and extremely windy conditions can affect the operation of the Zone20 H.
- When working in a very dusty environment place the Zone20 H up-wind so the dirt is blown away from the laser.

### Setting up on a Tripod



011250.001

| Step | Description  |
|------|--|
| 1.   | Set up the tripod.   |
| 2.   | Place the Zone20 H on the tripod.  |
| 3.   | Tighten the screw on the underside of the tripod to secure the Zone20 H on the tripod. |

- Attach the Zone20 H securely to a tripod or laser trailer, or mount on a stable level surface.
- Always check the tripod or laser trailer before attaching the Zone20 H. Make sure all screws, bolts and nuts are tight.
- If a tripod has chains, they should be slightly loose to allow for thermal expansion during the day.
- Secure the tripod on extremely windy days.

# 3 Operation

## 3.1 Buttons

### Buttons

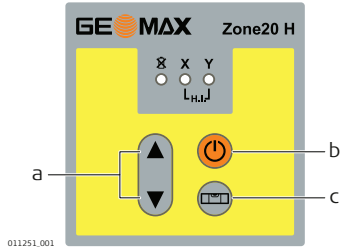

- a) Up and Down Arrow buttons
- b) Power button
- c) Automatic/Manual Mode button

### Description of the Buttons

| Button                | Function   |
|-----------------------|--|
| Up and Down Arrow     | Press to enter a slope for an axis in Manual Mode.   |
| Power                 | Press to turn on or off the Zone20 H.  |
| Automatic/Manual Mode | Press once to change the X-axis to Manual Mode with Y-axis self-levelling.   |
|                       | Press again to change the Y-axis to Manual Mode with X-axis self-levelling.  |
|                       | Press again to change both axes to Manual Mode with no self-levelling.   |
|                       | Press again to change back to Full Automatic Mode.   |
|                       | Note the changes in the LED indicators in the Manual Modes. The red LED indicates that the corresponding axis is in Manual Mode. |

## 3.2 LED Indicators

### Main Functions

#### Description

The LED Indicators have three main functions:

- To indicate the level status of the axes.
- To indicate the battery status.
- To indicate an H.I. Alert condition.

#### Diagram of the LED Indicators

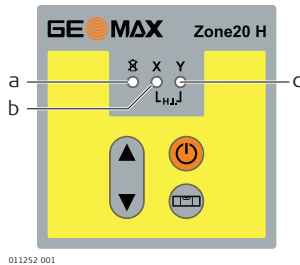

- a) Low Battery Indicator LED
- b) X-axis Indicator LED
- c) Y-axis Indicator LED

### Description of the LEDs

| IF the  | is/are            | THEN                        |
|---|-------------------|-----------------------------|
| Low Battery Indicator LED (Li-Ion & alkaline) | off               | the battery is okay.        |
|   | on                | the battery is getting low. |
| X-axis and Y-axis Indicator LEDs              | green             | the axis is level.          |
|   | flashing green    | the axis is levelling.      |
|   | red               | the axis is in Manual Mode. |
|   | both flashing red | an H.I. Alert is indicated. |

### 3.3

## Turning the Zone20 H on and off

---

#### Turning on and off

Press the Power button to turn on or off the Zone20 H.

##### After turning on:

- If set up within the 5° self-levelling range, the Zone20 H automatically levels to create an accurate horizontal plane of laser light.
  - Once levelled, the head starts rotating and Zone20 H is ready for use.
  - After 30 seconds of completing the levelling, the H.I. Alert system becomes active to protect the laser against changes in elevation caused by movement or settling of the tripod.
  - The self-levelling system and H.I. Alert function continues to monitor the position of the laser beam to ensure consistent and accurate work.
- 

### 3.4

## Automatic Mode

---

#### Description of the Automatic Mode

The Zone20 H always starts up in Automatic Mode.  
In Automatic Mode the Zone20 H automatically levels if set up within the 5° self-levelling range.

---

### 3.5

## Manual Mode

---

#### Description of the Manual Mode

After start-up the Manual Mode can be activated. In Manual Mode the self-levelling will be deactivated. The following options are available:

- Change the X-axis to Manual Mode
- Change the Y-axis to Manual Mode
- Change to Full Manual Mode

 After turning the Zone20 H off and on again, the Zone20 H is in Automatic Mode.

---

#### Changing the X-axis to Manual Mode

After startup, press the Automatic/Manual Mode Button once to change the X-axis to Manual Mode.  
 The X-axis and Y-axis are marked on the top of the Zone20 H.

- The X-axis does not self-level and a slope can be entered in this axis using the Up and Down Arrow buttons on the Zone20 H.
- The X-axis LED is red.
- The Y-axis continues to self-level and the Y-axis LED flashes green until level.



When the X-axis is in Manual Mode, the X-axis can be sloped upwards or downwards as illustrated.



011300.001

---

### Changing the Y-axis to Manual Mode

Press the Automatic/Manual Mode button again to change the Y-axis to Manual Mode.

 The X-axis and Y-axis are marked on the top of the Zone20 H.

- The Y-axis does not self-level and a slope can be entered in this axis using the Up and Down Arrow buttons on the Zone20 H.
- The Y-axis LED is red.
- The X-axis continues to self-level and the X-axis LED flashes green until level.



When the Y-axis is in Manual Mode, the Y-axis can be sloped upwards or downwards as illustrated.



005789.001

### Changing to Full Manual Mode

Press the Automatic/Manual Mode button again to change to Full Manual Mode.

 The X and Y axes are marked on the top of the Zone20 H.

- Both the X-axis and Y-axis do not self-level and a slope can be entered in the Y-axis using the Up and Down Arrow buttons on the Zone20 H.
- The X-axis LED is red.
- The Y-axis LED is red.



When both the X-axis and Y-axis are in Manual Mode, the Y-axis can be sloped using the Up and Down Arrow buttons.



011302.001

## 3.6

### Elevation Alert (H.I.) Function

#### Description of the Elevation Alert function

- The Elevation Alert or Height of Instrument (H.I.) function prevents incorrect work caused by movement or settling of the tripod that would cause the laser to level at a lower height.
- The Elevation Alert function becomes active and monitors the movement of the laser 30 second after the Zone20 H has completely levelled and the head of the laser starts rotating.
- The Elevation Alert monitors the laser. If disturbed, both the X-axis LED and Y-axis LED flash and the Zone20 H beeps rapidly.
- To stop the alert turn Zone20 H off and on again. Check the height of the laser before beginning to work again.

 The Elevation Alert function turns on automatically every time the Zone20 H is turned on.

#### Disable or enable the Elevation Alert function

The Elevation Alert function can be disabled or enabled by pressing the following button combination:

- With the Zone20 H turned on, press and hold the Up and Down Arrow buttons.
- Press the Automatic/Manual Mode button.

 The Zone20 H beeps once to indicate the change.

# 4

## Receivers

**Description** The Zone20 H is sold with the ZRB35, ZRP105 or ZRD105 Receiver.

### 4.1 ZRB35 Receiver

**Instrument components**  
part 1 of 2

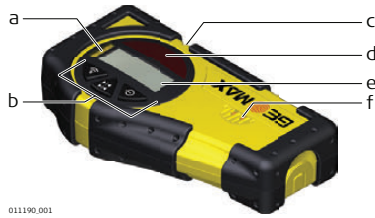

- a) Level vial
- b) Keypad
- c) On-grade
- d) Laser Reception window
- e) LCD window
- f) Audio Speaker

| Component              | Description   |
|------------------------|---|
| Level vial             | Aids to keep the rod plumb when taking readings.  |
| Keypad                 | Power, accuracy and volume functions.   |
| On-grade               | Indicates the on-grade position of the laser.   |
| Laser Reception window | Detects the laser beam. The reception windows must be directed towards the laser.   |
| LCD window             | Front and rear LCD arrow indicate the detector's position.  |
| Audio Speaker          | Indicates the detector's position: <ul style="list-style-type: none"> <li>• High - Fast beeping</li> <li>• On-grade - Solid tone</li> <li>• Low - Slow beeping</li> </ul> |

**Instrument components**  
part 2 of 2



- a) Bracket Mounting Hole
- b) Offset notch
- c) Battery door
- d) Serial number label
- e) Product label

| Component             | Description   |
|-----------------------|---|
| Bracket Mounting Hole | Location to attach the receiver bracket for normal operation.                             |
| Offset notch          | Use to transfer reference marks. The notch is 45 mm (1.75") below to top of the detector. |
| Battery door          | Access to the battery compartment.  |

**Description of the buttons**



- a) Audio
- b) Bandwidth
- c) Power

| Button    | Function                             |
|-----------|--------------------------------------|
| Audio     | Press to change the audio output.    |
| Bandwidth | Press to change detection bandwidth. |
| Power     | Press once to turn on the Receiver.  |

Instrument components  
part 1 of 2



011193.001

- a) Level vial
- b) Audio Speaker
- c) LCD window
- d) LEDs
- e) Laser Reception window
- f) On-grade
- g) Keypad

| Component              | Description   |
|------------------------|---|
| Level vial             | Aids to keep the rod plumb when taking readings.  |
| Audio Speaker          | Indicates the detector's position: <ul style="list-style-type: none"> <li>• High - Fast beeping</li> <li>• On-grade - Solid tone</li> <li>• Low - Slow beeping</li> </ul>                   |
| LCD window             | Front and rear LCD arrow indicate the detector's position.  |
| LEDs                   | Display the relative position of the laser beam. Three channel indication: <ul style="list-style-type: none"> <li>• High - Red</li> <li>• On-grade - Green</li> <li>• Low - Blue</li> </ul> |
| Laser Reception window | Detects the laser beam. The reception windows must be directed towards the laser.   |
| On-grade               | Indicates the on-grade position of the laser.   |
| Keypad                 | Power, accuracy and volume functions.   |

Instrument components  
part 2 of 2



011194.001

- a) Bracket Mounting Hole
- b) Offset notch
- c) Product label
- d) Battery door

| Component             | Description   |
|-----------------------|---|
| Bracket Mounting Hole | Location to attach the receiver bracket for normal operation.                             |
| Offset notch          | Use to transfer reference marks. The notch is 85 mm (3.35") below to top of the detector. |
| Product label         | The serial number is located inside the battery compartment.                              |
| Battery door          | Access to the battery compartment.  |



## Description of the Buttons



- a) Power
- b) Audio
- c) Bandwidth

| Button    | Function                             |
|-----------|--------------------------------------|
| Power     | Press once to turn on the Receiver.  |
| Audio     | Press to change the audio output.    |
| Bandwidth | Press to change detection bandwidth. |

## Menu access and navigation

To access the menu of the ZRP105 Receiver, press the Bandwidth button and Audio button simultaneously.

- Use the Bandwidth button and Audio button to change parameters.
- Use the Power button to scroll through the menu.

## Menu

 MENU MODE - The blue LED will blink slowly indicating menu mode.

| Menu  | Function  | Indication   |
|---|---|--|
| LED<br>Red and Green LEDs change brightness to indicate this parameter. | Changes the brightness of the LED indicators.                     | Red and green LEDs - High/Low/Off  |
| BAT<br>The laser icon flashes to indicate this parameter.               | Turns on or off the Laser low battery indication on the receiver. | Green LED is on: Laser low battery icon function is active.<br>Red LED is on: Laser low battery icon function is not active. |
| MEM<br>The down arrow bars are filling to indicate this parameter.      | Turns on or off the position memory function.                     | Green LED is on: function is on.<br>Red LED is on: function is off.  |

## 4.3

### ZRD105, Digital Receiver

The ZRD105 Digital Receiver provides you with basic position information by using an arrow display plus digital readout.

## Instrument components



- a) Speaker
- b) LCD Digital Display
- c) LED Display
- d) Power button
- e) Target button
- f) Reception window
- g) Bandwidth button
- h) Audio button

## Description of the Buttons

| Button    | Function                                    |
|-----------|---|
| Power     | Press once to turn on the receiver.         |
|           | Press 1.5 seconds to turn off the receiver. |
| Target    | Press to capture the digital reading.       |
| Bandwidth | Press to change detection bandwidths.       |
| Audio     | Press to change the audio output.           |

# 5 Applications

## 5.1 Setting Forms

### Setting Forms step-by-step

Application shown using the ZRP105 Receiver.

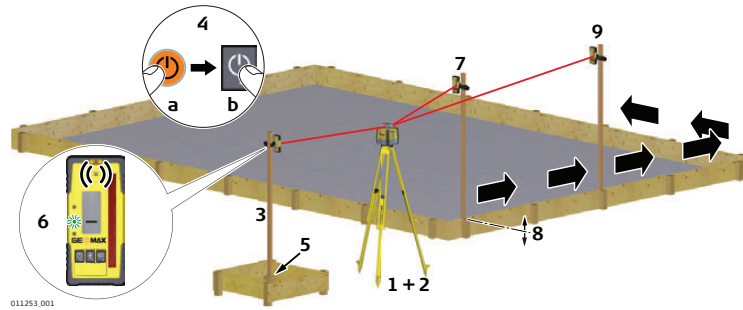

| Step | Description  |
|------|--|
| 1.   | Set up the Zone20 H on a tripod.   |
| 2.   | Set up the tripod on a stable surface outside the working area.  |
| 3.   | Attach the receiver to a rod.  |
| 4.   | Turn on the Zone20 H and the receiver.   |
| 5.   | Set the base of the rod on a known point for the finished height of forms.   |
| 6.   | Adjust the height of the receiver on the rod until the on-grade (centre-line) position is indicated on the receiver by: <ul style="list-style-type: none"> <li>the centre bar</li> <li>the green flashing LED</li> <li>a solid audio tone</li> </ul> |
| 7.   | Set the rod with the attached receiver on top of the form.   |
| 8.   | Adjust the height of the form until the on-grade position is again indicated.  |
| 9.   | Continue to additional positions until the forms are levelled to the rotating plane of the Zone20 H.   |

## 5.2 Checking Grades

### Checking Grades step-by-step

Application shown using the ZRP105 Receiver.

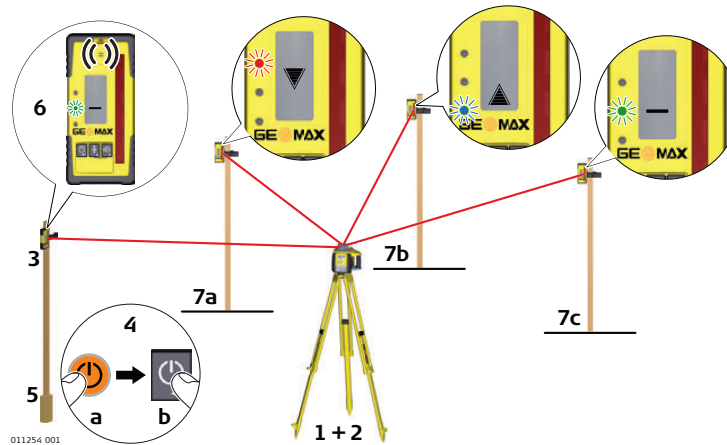

| Step | Description  |
|------|--|
| 1.   | Set up the Zone20 H on a tripod.                                 |
| 2.   | Set up the tripod on a stable surface outside the working area.  |
| 3.   | Attach the receiver to a rod.                                    |
| 4.   | Turn on the Zone20 H and the receiver.                           |
| 5.   | Set the base of the rod on a known point for the finished grade. |

| Step | Description  |
|------|--|
| 6.   | Adjust the height of the receiver on the rod until the on-grade (centre-line) position is indicated on the receiver by: <ul style="list-style-type: none"> <li>the centre bar</li> <li>the green flashing LED</li> <li>a solid audio tone</li> </ul> |
| 7.   | Set the rod with the attached receiver on top of the excavation or concrete pour to check for correct elevation.   |
| 8.   | Variances can be read in precise measurements with the digital receiver. <ul style="list-style-type: none"> <li>7a: Position is too high.</li> <li>7b: Position is too low.</li> <li>7c: Position is on grade.</li> </ul>                            |

### 5.3

### Manual Grades

#### Entering Grades step-by-step

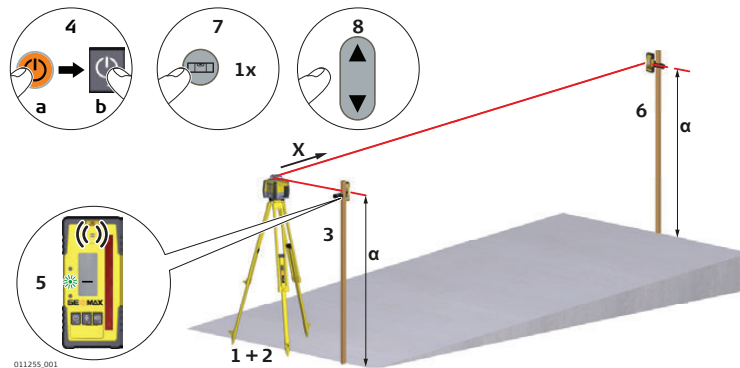

| Step | Description  |
|------|--|
| 1.   | Set up the Zone20 H on a tripod.   |
| 2.   | Set up the tripod at the base of the slope with the x-axis pointing in the direction of the slope.   |
| 3.   | Turn on the Zone20 H.  |
| 4.   | Press the Grade button.  |
| 5.   | Press the Up or Down button to enter grade for the x-axis (single slope). Press the Grade button to enter grade for the y-axis. Press the Grade button again to exit grade entry mode. |
| 6.   | Once grade is entered, the Zone20 H will begin to adjust to grade. Do not disturb the Zone20 H during this process.  |

To restore previous grade, press and hold the Grade button for 1.5 seconds.

# 6 Batteries

**Description** The Zone20 H can be purchased with alkaline batteries or a rechargeable Li-Ion battery pack. The following information is appropriate only to the model you have purchased.

## 6.1 Operating Principles

**First-time Use / Charging Batteries**

- The battery must be charged prior to using it for the first time because it is delivered with an energy content as low as possible.
- The permissible temperature range for charging is between 0°C to +40°C/ +32°F to +104°F. For optimal charging, we recommend charging the batteries at a low ambient temperature of +10°C to +20°C/+50°F to +68°F if possible.
- It is normal for the battery to become warm during charging. Using the chargers recommended by GeoMax, it is not possible to charge the battery if the temperature is too high.
- For new batteries or batteries that have been stored for a long time (> three months), it is effectual to make only one charge/discharge cycle.
- For Li-Ion batteries, a single discharging and charging cycle is sufficient. We recommend carrying out the process when the battery capacity indicated on the charger or on a GeoMax product deviates significantly from the actual battery capacity available.

**Operation / Discharging**

- The batteries can be operated from -20°C to +55°C/-4°F to +131°F.
- Low operating temperatures reduce the capacity that can be drawn; high operating temperatures reduce the service life of the battery.

## 6.2 Battery for Zone20 H

**Charging the Li-Ion battery pack step-by-step**

The rechargeable Li-Ion battery pack on the Zone20 H can be charged without removing the battery pack from the laser.



| Step | Description   |
|------|---|
| 1.   | Slide the locking mechanism on the battery compartment to the centre position to expose the charge jack.  |
| 2.   | Plug the AC connector into the appropriate AC power source.   |
| 3.   | Connect the charger plug into the charge jack on the Zone20 H battery pack.   |
| 4.   | The small LED next to the charge jack flashes indicating that the Zone20 H is charging. The LED is on solid when the battery pack is fully charged. |
| 5.   | When the battery pack is fully charged, disconnect the charger plug from the charge jack.   |
| 6.   | Slide the locking mechanism to the left to prevent dirt from getting into the charging jack.  |

The battery pack reaches a full charge in approximately 5 hours if completely empty. A one-hour charge should allow the Zone20 H to run for a full 8 hours.

### Changing the Li-Ion batteries step-by-step

With the rechargeable Li-Ion battery pack the battery indicator on the Zone20 H LCD display shows when the battery pack is low and needs to be charged.

The charge indicator LED on the Li-Ion battery pack indicates when the pack is being charged (flashing slowly) or fully charged (on, not flashing).



011257.001

| Step | Description   |
|------|---|
|      | The batteries are inserted in the front of the laser.   |
|      | The rechargeable battery pack can be recharged without being removed from the laser. Refer to " Charging the Li-Ion battery pack step-by-step" for further information. |
| 1.   | Slide the locking mechanism on the battery compartment to the right and open the cover of the battery compartment.  |
| 2.   | To remove the batteries:<br>Remove the batteries from the battery compartment.  |
|      | To insert the batteries:<br>Insert the batteries into the battery compartment.  |
| 3.   | Close the cover of the battery compartment and slide the locking mechanism to the left until it locks into position.  |

### Changing the alkaline batteries step-by-step

With alkaline batteries the battery indicator on the Zone20 H LCD display flashes when the batteries are low and need to be replaced. If no battery icon is shown, the batteries are okay.



011258.001

| Step | Description  |
|------|--|
|      | The batteries are inserted in the front of the laser.  |
| 1.   | Slide the locking mechanism on the battery compartment to the right and open the cover of the battery compartment.   |
| 2.   | To remove the batteries:<br>Remove the batteries from the battery compartment.   |
|      | To insert the batteries:<br>Insert the batteries into the battery compartment, ensuring that the contacts are facing in the right direction.<br>The correct polarity is displayed on the battery holder. |
| 3.   | Close the cover of the battery compartment and slide the locking mechanism to the left until it locks into position.   |

## About

- It is the responsibility of the user to follow operating instructions and to periodically check the accuracy of the laser and work as it progresses.
- The Zone20 H is adjusted to the defined accuracy specification at the factory. It is recommended to check the laser for accuracy upon receipt and periodically thereafter to ensure accuracy is maintained. If the laser requires adjustment, contact your nearest authorised service centre or adjust the laser using the procedures described in this chapter.
- Only enter the accuracy adjustment mode when you plan to change the accuracy. Accuracy adjustments should only be performed by a qualified individual that understands basic adjustment principles.
- It is recommended to perform this procedure with two people on a relatively flat surface.

## 7.1

## Checking the Level Accuracy

## Checking the level accuracy step-by-step

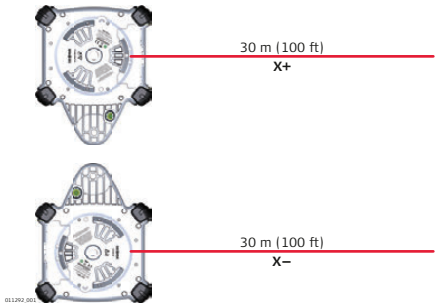
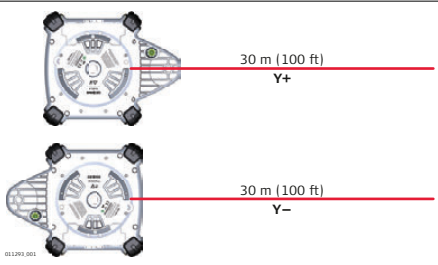
| Step | Description  |
|------|--|
| 1.   | Place the Zone20 H on a flat, level surface or tripod approximately 30 m (100 ft) from a wall.   |
|      |   |
| 2.   | Align the first axis so that it is square to a wall. Allow the Zone20 H to self-level completely (approximately 1 minute after the Zone20 H begins to rotate). |
| 3.   | Mark the position of the beam.   |
| 4.   | Rotate the laser 180° and allow it to self-level.  |
| 5.   | Mark the opposite side of the first axis.  |
|      |   |
| 6.   | Align the second axis of the Zone20 H by rotating it 90° so that this axis is square to the wall. Allow the Zone20 H to self-level completely.                 |
| 7.   | Mark the position of the beam.   |
| 8.   | Rotate the laser 180° and allow it to self-level.  |
| 9.   | Mark the opposite side of the second axis.   |



The Zone20 H is within its accuracy specification if the four marks are within  $\pm 1.5$  mm ( $\pm 1/16$ "") from the centre.

**Description**

In Adjustment Mode the X-axis LED indicates changes to the X-axis.

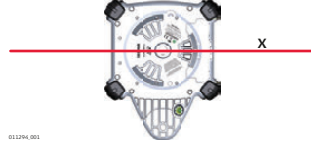

The Y-axis LED indicates changes to the Y-axis

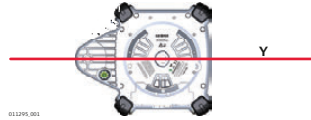

**Entering adjustment mode step-by-step**

| Step | Description  |
|------|--|
| 1.   | Turn off the power.                                    |
| 2.   | Press and hold both the Up and Down Arrow buttons.     |
| 3.   | Press the Power button. The active axis is the X-axis. |

The following sequence of LED behaviour occurs:

- The X-axis and the Y-axis LEDs flash alternately three times.
- The X-axis LED flashes three times, then flashes slowly until level. When the Zone20 H is level, the X-axis LED is on, but does not flash.
- The Y-axis LED is off.

**Adjusting the X-axis step-by-step**

| Step | Description  |
|------|--|
| 1.   | Press the Up and Down Arrow buttons to increment the laser beam up and down. Each increment is indicated by a flash of the X-axis LED and a beep from the audio indicator.   |
| 2.   | Continue to press the Up and Down Arrow buttons and monitor the spot until the Zone20 H is within its specified range.<br> Five steps are equal to 10 arc seconds of change, or approximately 1.5 mm at 30 m (1/16" at 100'). |
| 3.   | Press the Automatic/Manual Mode button to switch to the Y-axis.  |

The following sequence of LED behaviour occurs:

- The X-axis and the Y-axis LEDs flash alternately three times.
- The Y-axis LED flashes three times, then flashes slowly until level. When the Zone20 H is level, the Y-axis LED is on, but does not flash.
- The X-axis LED is off.

**Adjusting the Y-axis step-by-step**

| Step | Description  |
|------|--|
| 1.   | Press the Up and Down Arrow buttons to increment the laser beam up and down. Each increment is indicated by a flash of the Y-axis LED and a beep from the audio indicator.   |
| 2.   | Continue to press the Up and Down Arrow buttons and monitor the spot until the Zone20 H is within its specified range.<br> Five steps are equal to 10 arc seconds of change, or approximately 1.5 mm at 30 m (1/16" at 100'). |
| 3.   | Press the Automatic/Manual Mode button to switch back to the X-axis if desired.  |



**Exiting adjustment mode step-by-step**

Press and hold the Automatic/Manual Mode button for 3 seconds to save and exit Adjustment Mode. The X-axis LED and Y-axis LED flash alternately three times, then the Zone20 H shuts off.



Pressing the Power button at any time while in Adjustment Mode will exit the mode without saving changes.

## Alerts

| Alert   | Symptom  | Possible causes and solutions  |
|---|--|--|
|  | Low Battery LED flashes red, or is on but not flashing.              | The batteries are low. Replace the alkaline batteries or recharge the Li-Ion battery pack. Refer to "6 Batteries".   |
|  | Elevation (H.I.) Alert<br>The LEDs flash quickly with an audio beep. | The Zone20 H has been bumped or tripod was moved. Turn off Zone20 H to stop alert check the height of the laser before beginning to work again. Allow Zone20 H to re-level and check the height of the laser.<br>After two minutes in the alert condition, the unit will shut off automatically.     |
|  | Servo Limit Alert<br>All LEDs flash sequentially.                    | The Zone20 H is tipped too far to reach a level position. Re-level the Zone20 H within the 5 degree self-levelling range.<br>This alert will also be displayed any time the unit is tipped more than 45° from level. After two minutes in the alert condition, the unit will shut off automatically. |

## Troubleshooting

| Problem  | Possible Cause(s)  | Suggested Solutions   |
|--|--|---|
| The Zone20 H is working, but not self-levelling. | The Zone20 H is in Manual Mode.  | The Zone20 H must be in Automatic Mode to self-level. Set the Zone20 H to Automatic Mode by pressing the Automatic/Manual Mode button. <ul style="list-style-type: none"> <li>– In Automatic Mode the X-axis LED and the Y-axis LED flash green while levelling.</li> <li>– In Manual Mode the X-axis LED and/or the Y-axis LED are red.</li> </ul> |
| Zone20 H does not turn on.                       | The batteries are low or dead.   | Check the batteries and change or charge the batteries if necessary. If the problem continues, return the Zone20 H to an authorised service centre for service.   |
| The distance of the laser is reduced.            | Dirt is reducing the laser output.                                       | Clean the windows of the Zone20 H and the receiver. If the problem continues, return the Zone20 H to an authorised service centre for service.  |
| The laser receiver is not working properly.      | The Zone20 H is not rotating. It may be levelling or in Elevation Alert. | Check for proper operation of the Zone20 H.<br> Refer to the receiver manual for more information.   |
|  | The receiver is out of usable range.                                     | Move closer to the Zone20 H.  |
|  | The batteries of the receiver are low.                                   | Change the receiver batteries.  |
| Elevation Alert function is not working.         | The Elevation Alert function is disabled.                                | The Elevation Alert function is enabled or disabled by pressing the following button combination:<br>With Zone20 H turned on and rotating, press and hold the Up and Down Arrow buttons. Then press the Automatic/Manual Mode button to enable or disable the Elevation Alert function. The Zone20 H beeps once to indicate the change.             |



| Problem  | Possible Cause(s)            | Suggested Solutions  |
|--|------------------------------|--|
| The Zone20 H does not switch to Manual Mode. The Zone20 H beeps three times when the Automatic/Manual Mode button is pressed and does not change to Manual Mode. | The Manual Mode is disabled. | The Manual Mode can be enabled or disabled by pressing the following button combination:<br>With the Zone20 H turned off, press and hold both the Automatic/Manual Mode button and the Power button for 5 seconds. The Zone20 H will beep five times, then give a longer beep at the end to indicate the change. |

## 9 Care and Transport

### 9.1 Transport

|   |  |
|---|--|
| <b>Transport in the field</b>           | When transporting the equipment in the field, always make sure that you <ul style="list-style-type: none"> <li>• either carry the product in its original transport container,</li> <li>• or carry the tripod with its legs splayed across your shoulder, keeping the attached product upright.</li> </ul> |
| <b>Transport in a road vehicle</b>      | Never carry the product loose in a road vehicle, as it can be affected by shock and vibration. Always carry the product in its transport container, original packaging or equivalent and secure it.  |
| <b>Shipping</b>                         | When transporting the product by rail, air or sea, always use the complete original GeoMax packaging, transport container and cardboard box, or its equivalent, to protect against shock and vibration.  |
| <b>Shipping, transport of batteries</b> | When transporting or shipping batteries, the person responsible for the product must ensure that the applicable national and international rules and regulations are observed. Before transportation or shipping, contact your local passenger or freight transport company.                               |
| <b>Field adjustment</b>                 | Periodically carry out test measurements and perform the field adjustments indicated in the User Manual, particularly after the product has been dropped, stored for long periods or transported.  |

### 9.2 Storage

|                                      |  |
|--------------------------------------|--|
| <b>Product</b>                       | Respect the temperature limits when storing the equipment, particularly in summer if the equipment is inside a vehicle. Refer to "10 Technical Data" for information about temperature limits.   |
| <b>Field adjustment</b>              | After long periods of storage inspect the field adjustment parameters given in this user manual before using the product.  |
| <b>Li-Ion and alkaline batteries</b> | <p><b>For Li-Ion and alkaline batteries</b></p> <ul style="list-style-type: none"> <li>• Refer to "Technical Data" for information about storage temperature range.</li> <li>• Remove batteries from the product and the charger before storing.</li> <li>• After storage recharge batteries before using.</li> <li>• Protect batteries from damp and wetness. Wet or damp batteries must be dried before storing or use.</li> </ul> <p><b>For Li-Ion batteries</b></p> <ul style="list-style-type: none"> <li>• A storage temperature range of 0°C to +30°C / +32°F to +86°F in a dry environment is recommended to minimize self-discharging of the battery.</li> <li>• At the recommended storage temperature range, batteries containing a 30% to 50% charge can be stored for up to one year. After this storage period the batteries must be recharged.</li> </ul> |

**Product and accessories**

- Blow dust off lenses and prisms.
  - Never touch the glass with your fingers.
  - Use only a clean, soft, lint-free cloth for cleaning. If necessary, moisten the cloth with water or pure alcohol. Do not use other liquids; these can attack the polymer components.
- 

**Damp products**

Dry the product, the transport container, the foam inserts and the accessories at a temperature not greater than 40°C /104°F and clean them. Remove the battery cover and dry the battery compartment. Do not repack until everything is completely dry. Always close the transport container when using in the field.

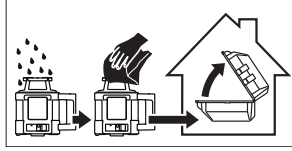
**Cables and plugs**

Keep plugs clean and dry. Blow away any dirt lodged in the plugs of the connecting cables.

---

# 10

## Technical Data

### 10.1

#### Conformity to National Regulations

##### Conformity to national regulations

For products which do not fall under R&TTE directive:



Hereby, GeoMax AG, declares that the product/s is/are in compliance with the essential requirements and other relevant provisions of the applicable European Directives. The declaration of conformity is available from GeoMax AG.

### 10.2

#### Dangerous Goods Regulations

##### Dangerous Goods Regulations

The products of GeoMax are powered by Lithium batteries.

Lithium batteries can be dangerous under certain conditions and can pose a safety hazard. In certain conditions, Lithium batteries can overheat and ignite.



When carrying or shipping your GeoMax product with Lithium batteries onboard a commercial aircraft, you must do so in accordance with the **IATA Dangerous Goods Regulations**.



GeoMax has developed **Guidelines** on "How to carry GeoMax products" and "How to ship GeoMax products" with Lithium batteries. Before any transportation of a GeoMax product, we ask you to consult these guidelines on our web page (<http://www.geomax-positioning.com/dgr>) to ensure that you are in accordance with the IATA Dangerous Goods Regulations and that the GeoMax products can be transported correctly.



Damaged or defective batteries are prohibited from being carried or transported onboard any aircraft. Therefore, ensure that the condition of any battery is safe for transportation.

### 10.3

#### General Technical Data of the Laser

##### Operating range

Operating range (diameter):

Zone20 H:

900 m/3000 ft

##### Self-levelling accuracy

Self-levelling accuracy:

±2.2 mm at 30 m (±3/32" at 100 ft)

Self-levelling accuracy is defined at 25°C (77°F)

##### Self-levelling range

Self-levelling range:

±5°

##### Rotation speed

Rotation speed:

10 rps

##### Laser dimensions



##### Weight

Zone20 H weight with battery:

3.06 kg/6.7 lbs.

**Internal battery**

| Type                      | Operating times* at 20°C |
|---------------------------|--------------------------|
| Lithium-Ion (Li-Ion Pack) | 40 h                     |
| Alkaline (four D-cells)   | 60 h                     |

\*Operating times are dependent upon environmental conditions.

 Charging the Li-Ion battery pack takes a maximum of five hours.

 Use only high quality alkaline batteries to achieve operating time.

**Environmental specifications****Temperature**

| Operating temperature               | Storage temperature                |
|-------------------------------------|------------------------------------|
| -10°C to +50°C<br>(+14°F to +122°F) | -20°C to +70°C<br>(-4°F to +158°F) |

**Protection against water, dust and sand**

| Protection                             |
|--|
| IP67 (IEC 60529)                       |
| Dust tight                             |
| Waterproof to 1 m temporary immersion. |

**Lithium-Ion charger**

|                 |                                |
|-----------------|--------------------------------|
| Type:           | Li-Ion battery charger         |
| Input voltage:  | 100 V AC-240 V AC, 50 Hz-60 Hz |
| Output voltage: | 12 V DC                        |
| Output current: | 3.0 A                          |
| Polarity:       | Shaft: negative, Tip: positive |

**Lithium-Ion battery pack**

|                |                           |
|----------------|---------------------------|
| Type:          | Li-Ion battery pack       |
| Input voltage: | 12 V DC                   |
| Input current: | 2.5 A                     |
| Charge time:   | 5 hours (maximum) at 20°C |



# GeoMax Zone20 H Series



**841853-1.0.1en**

Original text

© 2015 GeoMax AG, Widnau, Switzerland

**GeoMax AG**  
[www.geomax-positioning.com](http://www.geomax-positioning.com)

