

Robert Bosch GmbH
Power Tools Division
70745 Leinfelden-Echterdingen
Germany

www.bosch-pt.com

1 609 929 W93 (2010.05) T / 214 XXX



1 609 929 W93

GOL Professional

20 D | 20 G | 26 D | 26 G



de Originalbetriebsanleitung	pl Instrukcja oryginalna	lv Instrukcijas oriģinālvalodā
en Original instructions	cs Původní návod k používání	lt Originali instrukcija
fr Notice originale	sk Pôvodný návod na použitie	cn 正本使用说明书
es Manual original	hu Eredeti használati utasítás	tw 正本使用說明書
pt Manual original	ru Оригинальное руководство по эксплуатации	ko 사용 설명서 원본
it Istruzioni originali	uk Оригінальна інструкція з експлуатації	th หนังสือคู่มือการใช้งานฉบับต้นฉบับ
nl Oorspronkelijke gebruiksaanwijzing	ro Instrucțiuni originale	id Petunjuk-Petunjuk untuk Penggunaan Orisinal
da Original brugsanvisning	bg Оригинална инструкция	vi Bảng hướng dẫn nguyên bản
sv Bruksanvisning i original	sr Originalno uputstvo za rad	ar تعليمات التشغيل الأصلية
no Original driftsinstruks	sl Izvirna navodila	fa راهنمای طرز کار اصلی
fi Alkuperäiset ohjeet	hr Originalne upute za rad	
el Πρωτότυπο οδηγιών χρήσης	et Algupärane kasutusjuhend	
tr Orijinal işletme talimatı		



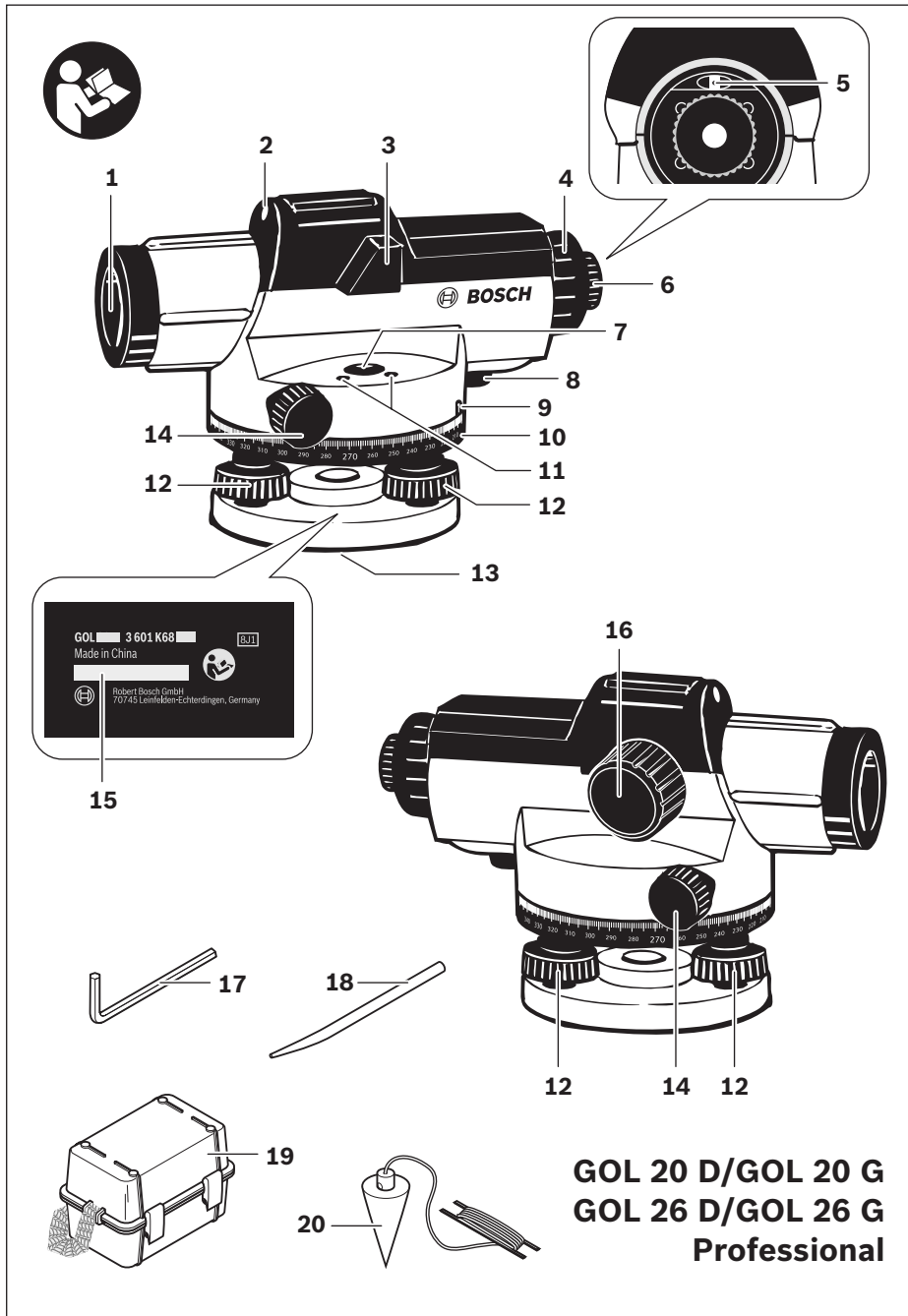

Safety Notes



Read and observe all instructions. SAVE THESE INSTRUCTIONS FOR FUTURE REFERENCE.

- ▶ **Have the measuring tool repaired only through qualified specialists using original spare parts.** This ensures that the safety of the measuring tool is maintained.

Functional Description

Please unfold the fold-out page with the representation of the measuring tool and leave it unfolded while reading the operating instructions.

Intended Use

The measuring tool is intended for determining and checking precise horizontal partitions. It is also suitable for measuring heights, distances and angles.

Product Features

The numbering of the product features shown refers to the illustration of the measuring tool on the graphic page.

- 1 Objective lens
- 2 Optical peep sight
- 3 Bubble vial mirror
- 4 Eyepiece cover
- 5 Adjusting screw for sighting line
- 6 Eyepiece
- 7 Circular bubble vial
- 8 Compensator lock
- 9 Horizontal circle reference mark
- 10 Horizontal circle
- 11 Adjusting screw of circular bubble vial
- 12 Levelling screw
- 13 Tripod mount 5/8" (on the rear side)
- 14 Horizontal drive screw
- 15 Serial number
- 16 Focusing knob
- 17 Allen key
- 18 Adjusting pin
- 19 Case
- 20 Plumb-bob

The accessories illustrated or described are not included as standard delivery.

Technical Data

Automatic level	GOL 20 D Professional	GOL 20 G Professional	GOL 26 D Professional	GOL 26 G Professional
Article number	3 601 K68 400	3 601 K68 401	3 601 K68 000	3 601 K68 001
Working range	60 m	60 m	100 m	100 m
Height accuracy for an individual measurement	3 mm/30 m	3 mm/30 m	1.6 mm/30 m	1.6 mm/30 m
Accuracy of the bubble vial	8' / 2 mm	8' / 2 mm	8' / 2 mm	8' / 2 mm
Compensator				
– Levelling range	±15'	±15'	±15'	±15'
– Magnet dampening	●	●	●	●
Telescope				
– Image	erect	erect	erect	erect
– Magnification	20x	20x	26x	26x
– Field of view	1°30'	1°30'	1°30'	1°30'
– Clear objective aperture	36 mm	36 mm	36 mm	36 mm
– Minimum measuring distance	0.3 m	0.3 m	0.3 m	0.3 m
– Stadia ratio	100	100	100	100
– Stadia addition	0	0	0	0
Horizontal circle graduation	1°	1 gon	1°	1 gon
Tripod mount	5/8"	5/8"	5/8"	5/8"
Weight according to EPTA-Procedure 01/2003	1.7 kg	1.7 kg	1.7 kg	1.7 kg
Degree of protection	IP 54 (dust and splash water protected)	IP 54 (dust and splash water protected)	IP 54 (dust and splash water protected)	IP 54 (dust and splash water protected)

Please observe the article number on the type plate of your measuring tool. The trade names of the individual measuring tools may vary.

The measuring tool can be clearly identified with the serial number **15** on the type plate.

Operation

- ▶ **Check the levelling and indication accuracy of the measuring tool each time before using and after longer transport of the measuring tool.**
- ▶ **Protect the measuring tool against moisture and direct sun light.**

- ▶ **Do not subject the measuring tool to extreme temperatures or variations in temperature.** As an example, do not leave it in vehicles for longer periods. In case of large variations in temperature, allow the measuring tool to adjust to the ambient temperature before putting it into operation. In case of extreme temperatures or variations in temperature, the accuracy of the measuring tool can be impaired.

12 | English

- ▶ **Avoid any impact to or dropping of the measuring tool.** After severe exterior effects to the measuring tool, it is recommended to carry out an accuracy check (see “Accuracy Check of the Measuring Tool”, page 13) each time before continuing to work.
- ▶ **Place the measuring tool in the provided case when transporting it over larger distances (e.g. in the car). Ensure that the measuring tool is correctly placed in the transport case.** When placing the measuring tool in the case, the compensator is locked; otherwise, it could be damaged in case of intense movement.

Setting Up/Aligning the Measuring Tool

Mounting on the Tripod

Set up the tripod stable and safe against tipping over or slipping off. Place the measuring tool via the tripod mount **13** onto the male thread of the tripod and screw the measuring tool tight with the locking screw of the tripod.

Roughly level the tripod.

Over short distances, the measuring tool can be carried mounted on the tripod. To ensure that the measuring tool is not damaged during this, the tripod must be held vertically during transport, and should not be carried lengthwise over the shoulder.

Aligning the Measuring Tool

Align the measuring tool with the levelling screws **12** so that the air bubble is positioned in the centre of the circular bubble vial **7**.

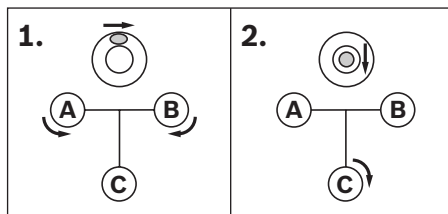

Turn the first two levelling screws **A** and **B** to move the air bubble so that it is centred between the two levelling screws. Then turn the third levelling screw **C** until the air bubble is positioned in the centre of the circular bubble vial.

Any remaining deviation of the measuring tool to the horizontal plane following the balancing of the circular bubble vial is compensated by means of the compensator.

While working, regularly check (e.g. by viewing through the bubble vial mirror **3**) whether the air bubble is still in the centre of the circular bubble vial.

Centring the Measuring Tool over a Point on the Ground

If required, centre the measuring tool over a point on the ground. For this, hang the plumb-bob **20** onto the locking screw of the tripod.

Align the measuring tool above the point on the ground either by moving the measuring tool on the tripod or by adjusting the tripod.

Focusing the Telescope

Remove the lens cap from the objective lens **1**.

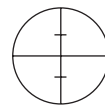

Direct the telescope against a bright object or hold a white sheet of paper in front of the objective lens **1**. Turn the eyepiece **6** until the crosshair appears sharp and deep black.

Direct the telescope towards the levelling rod, if required with help of the optical peep sight **2**.

Turn the focusing knob **16** until the graduation field of the levelling rod appears sharp. Align the crosshair exactly with the centre of the levelling rod by turning the horizontal drive screw **14**.

When the telescope is correctly focussed, the crosshair and the image of the levelling rod must remain aligned when moving your eye behind the eyepiece.

Measuring Functions

Always set up the levelling rod exactly vertical. Direct the aligned and focussed measuring tool against the levelling rod in such a manner that the crosshair faces centrally against the levelling rod.

Reading Off the Height

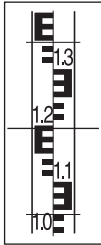

Read off the height of the levelling rod at the centre line of the cross-hair.

Height measured in the figure:
1.195 m.

Measuring a Distance

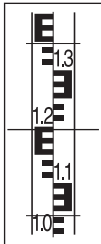

Centre the measuring tool above the point from which on the distance is to be measured.

Read off the height of the levelling rod at the top and bottom stadia lines. Multiply the difference of both heights by 100 to receive the distance from the measuring tool to the levelling rod.

Distance measured in the figure:
(1.347 m – 1.042 m) x 100 = 30.5 m.

Measuring Angles

Centre the measuring tool above the point from which on the angle is to be measured.

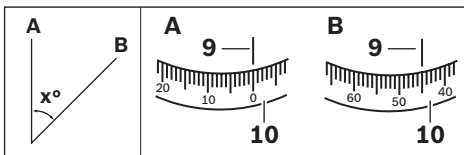

Direct the measuring tool against point **A**. Rotate the horizontal circle **10** with the zero point toward the reference mark **9**. Then direct the measuring tool against point **B**. Read off the angle at the reference mark **9**.

GOL 20 D/GOL 26 D: Angle measured in the example: 45°.

GOL 20 G/GOL 26 G: Angle measured in the example: 45 gon.

Accuracy Check of the Measuring Tool

Check the levelling and indication accuracy of the measuring tool each time before using and after longer transport of the measuring tool.

Checking the Circular Bubble Vial

Align the measuring tool with the levelling screws **12** so that the air bubble is positioned in the centre of the circular bubble vial **7**.

Rotate the telescope by 180°. When the air bubble is no longer in the centre of the circular bubble vial **7**, the circular bubble vial must be re-adjusted.

Readjusting the Circular Bubble Vial



Bring the air bubble of the circular bubble vial **7** in a position between the centre and the end position of the check by turning the levelling screws **12**.

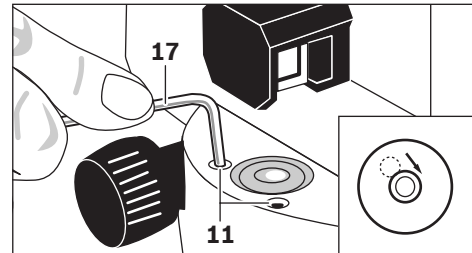

Using the Allen key **17**, turn the adjusting screws **11** until the air bubble is positioned in the centre of the circular bubble vial.

Check the circular bubble vial by rotating the telescope by 180°. If required, repeat the procedure or refer to an authorised Bosch after-sales service.

Checking the Compensator

After aligning and focussing the measuring tool, measure the height at a reference point. Then press the lock button of the compensator **8** and release again. Measure the height again at the reference point.

If both heights do not exactly match, have the measuring tool repaired by an authorised Bosch after-sales service.

14 | English

Checking the Crosshair

A measuring distance of approx. 30 m is required for the check. Set up the measuring tool in the centre and levelling rods **A** and **B** at both ends of the measuring distance.

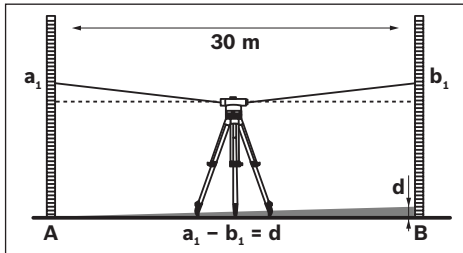

After aligning and focussing the measuring tool, read the heights at both levelling rods. Calculate the difference **d** between the height **a₁** of levelling rod **A** and the height **b₁** of levelling rod **B**.

Example:

$$a_1 = 1.937 \text{ m}$$

$$b_1 = 1.689 \text{ m}$$

$$a_1 - b_1 = 1.937 \text{ m} - 1.689 \text{ m} = 0.248 \text{ m} = d$$

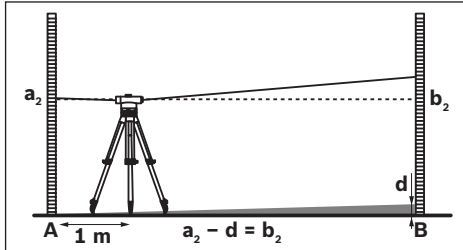

Set up the measuring tool approx. 1 m away from levelling rod **A**. After aligning and focussing the measuring tool, read the height **a₂** at levelling rod **A**.

Subtract the previously calculated value **d** from the measured height **a₂** in order to receive the set value for the height **b₂** at levelling rod **B**.

Measure height **b₂** at levelling rod **B**. When the measured value deviates by more than 6 mm (GOL 20 D/G) or 3 mm (GOL 26 D/G) from the calculated set value, the crosshair must be readjusted.

Example:

$$a_2 = 1.724 \text{ m}$$

$$d = 0.248 \text{ m}$$

$$a_2 - d = 1.724 \text{ m} - 0.248 \text{ m} = 1.476 \text{ m}$$

GOL 20 D/G: When measuring, height **b₂** must be 1.476 m ± 6 mm.

GOL 26 D/G: When measuring, height **b₂** must be 1.476 m ± 3 mm.

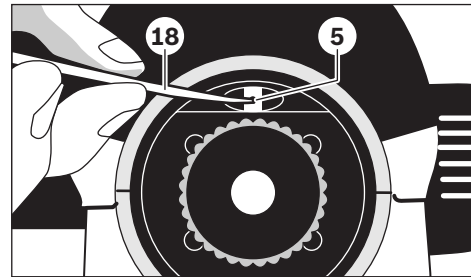
Readjusting the Crosshair

Unscrew the eyepiece cover **4**. Using the adjusting pin **18**, turn adjusting screw **5** clockwise or anticlockwise, until the calculated set value for height **b₂** is reached when measuring on levelling rod **B**.

Screw on eyepiece cover **4** again.

Example:

When measuring **b₂**, the value 1.476 m must be set.

Check the crosshair again. If required, repeat the procedure or refer to an authorised Bosch after-sales service.

Maintenance and Service

Maintenance and Cleaning

Store and transport the measuring tool only in the supplied case.

Keep the measuring tool clean at all times.

Do not immerse the measuring tool in water or other fluids.

Wipe off debris using a moist and soft cloth. Do not use any cleaning agents or solvents.

Handle the lenses with particular attention. Remove dust only with a soft brush. Do not touch the lenses with your fingers.

Before storing, allow the measuring tool and the case to dry completely. A bag of silica gel dryer for the removal of residual moisture is included in the case. Renew the bag of silica gel dryer regularly.

If the measuring tool should fail despite the care taken in manufacturing and testing procedures, repair should be carried out by an authorised after-sales service centre for Bosch power tools. Do not open the measuring tool yourself.

In all correspondence and spare parts orders, please always include the 10-digit article number given on the type plate of the measuring tool.

For repairs, only send in the measuring tool in the case.

After-sales Service and Customer Assistance

Our after-sales service responds to your questions concerning maintenance and repair of your product as well as spare parts. Exploded views and information on spare parts can also be found under:

www.bosch-pt.com

Our customer service representatives can answer your questions concerning possible applications and adjustment of products and accessories.

Great Britain

Robert Bosch Ltd. (B.S.C.)
P.O. Box 98
Broadwater Park
North Orbital Road
Denham
Uxbridge
UB 9 5HJ
Tel. Service: +44 (0844) 736 0109
Fax: +44 (0844) 736 0146
E-Mail: boschservicecentre@bosch.com

Ireland

Origo Ltd.
Unit 23 Magna Drive
Magna Business Park
City West
Dublin 24
Tel. Service: +353 (01) 4 66 67 00
Fax: +353 (01) 4 66 68 88

Australia, New Zealand and Pacific Islands

Robert Bosch Australia Pty. Ltd.
Power Tools
Locked Bag 66
Clayton South VIC 3169
Customer Contact Center
Inside Australia:
Phone: +61 (01300) 307 044
Fax: +61 (01300) 307 045
Inside New Zealand:
Phone: +64 (0800) 543 353
Fax: +64 (0800) 428 570
Outside AU and NZ:
Phone: +61 (03) 9541 5555
www.bosch.com.au

Republic of South Africa**Customer service**

Hotline: +27 (011) 6 51 96 00

Gauteng – BSC Service Centre

35 Roper Street, New Centre
Johannesburg

Tel.: +27 (011) 4 93 93 75

Fax: +27 (011) 4 93 01 26

E-Mail: bsctools@icon.co.za

KZN – BSC Service Centre

Unit E, Almar Centre

143 Crompton Street

Pinetown

Tel.: +27 (031) 7 01 21 20

Fax: +27 (031) 7 01 24 46

E-Mail: bsc.dur@za.bosch.com

Western Cape – BSC Service Centre

Democracy Way, Prosperity Park

Milnerton

Tel.: +27 (021) 5 51 25 77

Fax: +27 (021) 5 51 32 23

E-Mail: bsc@zsd.co.za

Bosch Headquarters

Midrand, Gauteng

Tel.: +27 (011) 6 51 96 00

Fax: +27 (011) 6 51 98 80

E-Mail: rbsa-hq.pts@za.bosch.com

People's Republic of China

Website: www.bosch-pt.com.cn

China Mainland

Bosch Power Tools (China) Co., Ltd.

567, Bin Kang Road

Bin Jiang District 310052

Hangzhou, P.R. China

Service Hotline: 800 8 20 84 84

Tel.: +86 (571) 87 77 43 38

Fax: +86 (571) 87 77 45 02

HK and Macau Special Administrative Regions

Robert Bosch Hong Kong Co. Ltd.

21st Floor, 625 King's Road

North Point, Hong Kong

Customer Service Hotline: +852 (21) 02 02 35

Fax: +852 (25) 90 97 62

E-Mail: info@hk.bosch.com

www.bosch-pt.com.cn

Indonesia

PT. Multi Tehaka

Kawasan Industri Pulogadung

Jalan Rawa Gelam III No. 2

Jakarta 13930

Indonesia

Tel.: +62 (21) 46 83 25 22

Fax: +62 (21) 46 82 86 45/68 23

E-Mail: sales@multitehaka.co.id

www.multitehaka.co.id

Philippines

Robert Bosch, Inc.

28th Floor Fort Legend Towers,

3rd Avenue corner 31st Street,

Fort Bonifacio Global City,

1634 Taguig City, Philippines

Tel.: +63 (2) 870 3871

Fax: +63 (2) 870 3870

matheus.contiero@ph.bosch.com

www.bosch-pt.com.ph

Bosch Service Center:

9725-27 Kamagong Street

San Antonio Village

Makati City, Philippines

Tel.: +63 (2) 899 9091

Fax: +63 (2) 897 6432

rosalie.dagdagan@ph.bosch.com

Malaysia

Robert Bosch (S.E.A.) Pte. Ltd.

No. 8A, Jalan 13/6

G.P.O. Box 10818

46200 Petaling Jaya

Selangor, Malaysia

Tel.: +60 (3) 7966 3194

Fax: +60 (3) 7958 3838

cheehoe.on@my.bosch.com

Toll-Free: 1800 880 188

www.bosch-pt.com.my

Thailand

Robert Bosch Ltd.
Liberty Square Building
No. 287, 11 Floor
Silom Road, Bangrak
Bangkok 10500
Tel.: +66 (2) 6 31 18 79 – 18 88 (10 lines)
Fax: +66 (2) 2 38 47 83
Robert Bosch Ltd., P. O. Box 2054
Bangkok 10501, Thailand

Bosch Service – Training Centre
2869-2869/1 Soi Ban Kluay
Rama IV Road (near old Paknam Railway)
Prakanong District
10110 Bangkok
Thailand
Tel.: +66 (2) 6 71 78 00 – 4
Fax: +66 (2) 2 49 42 96
Fax: +66 (2) 2 49 52 99

Singapore

Robert Bosch (SEA) Pte. Ltd.
11 Bishan Street 21
Singapore 573943
Tel.: +65 6571 2772
Fax: +65 6350 5315
leongheng.leow@sg.bosch.com
Toll-Free: 1800 333 8333
www.bosch-pt.com.sg

Vietnam

Robert Bosch Vietnam Co. Ltd
10/F, 194 Golden Building
473 Dien Bien Phu Street
Ward 25, Binh Thanh District
84 Ho Chi Minh City
Vietnam
Tel.: +84 (8) 6258 3690 ext. 413
Fax: +84 (8) 6258 3692
hieu.lagia@vn.bosch.com
www.bosch-pt.com

Disposal

Measuring tools, accessories and packaging should be sorted for environmental-friendly recycling.

Subject to change without notice.